

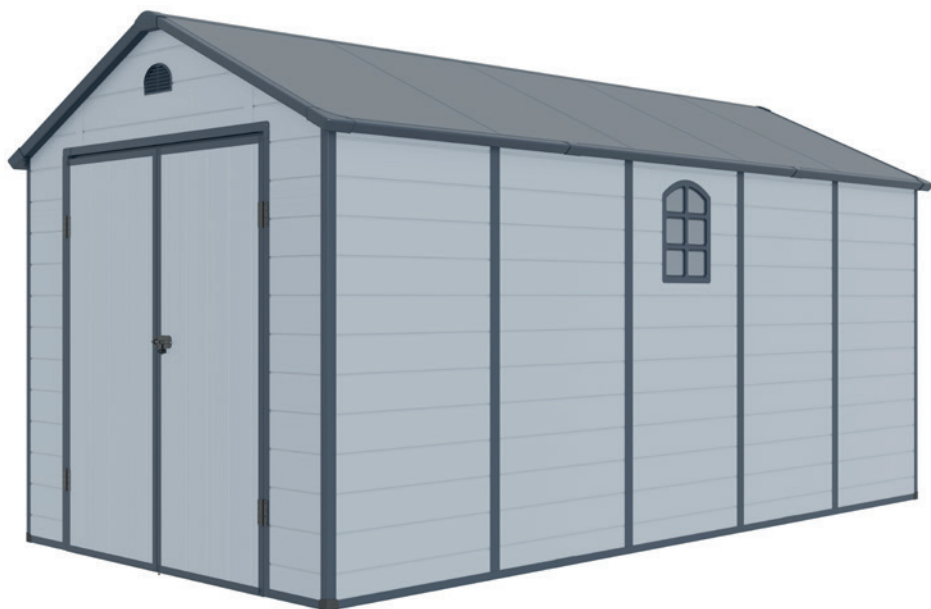

Manual

Garden House G21

Boston 1104



EN DE CZ SK HU PL

۲۱



Thank you for purchasing our product.

Before using this unit, please read this manual.

Assembly instructions:

Prior to the assembly please read all instructions and information carefully.

Check whether you have all parts which are necessary for the assembly.

The plastic shed has to be anchored to its base in order to prevent damage. The base is not included in the delivery and it has to be built separately.

Please mind your own safety.

1. Assemble the shed in dry, calm conditions. Do not assemble in windy conditions.
2. 2-4 persons are required for the assembly of this plastic shed.
3. Use protective clothing, gloves and goggles when assembling the shed.
4. During the assembly no children or pets should be present in the working area.

Care and maintenance:

1. Keep the doors closed and locked when the shed is not in use to prevent wind damage.
2. Clean the house using cloth and water.
3. Always remove fallen leaves from the roof as soon as possible to prevent them staining the roof. In case of snowfall remove the snow from the roof regularly. Large amounts of snow on the roof can damage the shed.
4. The house is not designed for living but only for storage purposes. Do not store hot items, such as recently used grills, blowtorches and volatile chemicals in the shed.



Vielen Dank für den Kauf unseres Produktes.

Bevor Sie dieses Gerät verwenden, lesen Sie diese Anleitung.

Montageanleitung:

Bevor Sie mit der Montage beginnen, lesen Sie sorgfältig alle Anweisungen und Informationen durch.

Überprüfen Sie, ob Ihnen alle notwendigen Teile für den Bau des Gartenhauses zur Verfügung stehen.

Das Gartenhaus muss ordnungsgemäß an der Grundplatte verankert werden, damit es bei starkem Wind nicht zur dessen Beschädigung oder Zerstörung kommt. Die Grundplatte ist nicht im Lieferumfang enthalten, diese muss getrennt gebaut werden.

Achten Sie auf Ihre Sicherheit.

1. Die Montage des Hauses ist an einem trockenen Ort und bei guten Wetterbedingungen durchzuführen.
2. Montieren Sie das Haus in 2-4 Personen.
3. Tragen Sie bei der Montage Schutzkleidung, Handschuhe und Schutzbrille.
4. Während der Montage sollten sich auf der Baustelle keine Kinder und Haustiere bewegen.

Pflege und Wartung:

1. Halten Sie die Tür geschlossen und verriegelt, um Beschädigungen durch Wind zu vermeiden.
2. Reinigen Sie das Haus mit einem Tuch und Wasser.
3. Entfernen Sie Laubblätter immer möglichst schnell, um Verfärbungen des Dachs zu vermeiden. Entfernen Sie den gefallenen Schnee regelmäßig vom Dach. Größere Schneemengen auf dem Dach können Schäden am Dach verursachen.
4. Das Haus ist nicht zum Wohnen, sondern zum Aufbewahren von Sachen vorgesehen. Im Gartenhaus dürfen keine heißen Gegenstände wie heiße Grills, UV-Lampen, flüchtige Chemikalien usw. gelagert werden.

Die deutsche Version der Anleitung ist eine genaue Übersetzung der Anleitung des Herstellers. Die in diesem Handbuch verwendeten Bilder dienen nur zur Illustration und können nicht genau das Produkt entsprechen.



Děkujeme za nákup našeho výrobku.

Před použitím si prosím přečtete tento návod.

Montážní návod:

Dříve, než začnete s montáží, pečlivě si prostudujte všechny pokyny a informace.

Zkontrolujte, zda máte všechny potřebné díly pro stavbu domku.

Domek musí být řádně ukotven k základové desce, aby nedošlo při silném větru k jeho poškození nebo zničení. Základová deska není součástí balení, je nutné si ji vybudovat samostatně.

Dbejte na svoji bezpečnost.

1. Montáž domku provádějte na suchém místě a za dobrých povětrnostních podmínek.
2. Domek montujte ve 2-4 lidech.
3. Při montáži používejte ochranný oděv, rukavice a ochranné brýle.
4. V době montáže by se po staveništi neměly pohybovat děti a domácí zvířata.

Péče a údržba:

1. Dveře od domku nechávejte zavřené a zamčené, aby nedošlo k poškození vlivem větru.
2. Domek čistěte za pomoci hadru a vody.
3. Vždy odstraňte spadané listí ze střechy co nejdříve, aby nedošlo k zbarvení střechy. Ze střechy pravidelně odstraňujte napadaný sníh. Větší nános sněhu na střeše může způsobit poškození střechy.
4. Domek není určen pro bydlení, ale pro ukládání věcí. V zahradním domku neskladujte horké předměty, jako např. rozpálený gril, opalovací lampy, těkavé chemikálie apod.

Česká verze návodu je přesným překladem originálního návodu výrobce.

Fotografie použité v manuálu jsou pouze ilustrační a nemusí se přesně shodovat s výrobkem.



Ďakujeme za nákup nášho výrobku.

Pred použitím si prosím prečítajte tento návod.

Montážny návod:

Skôr, než začnete s montážou, starostlivo si preštudujte všetky pokyny a informácie.

Skontrolujte, či máte všetky potrebné diely pre stavbu domčeka.

Domček musí byť riadne ukotvený k základnej doske, aby nedošlo pri silnom vetre k jeho poškodeniu alebo zničeniu. Základná doska nie je súčasťou balenia, je nutné si ju vybudovať samostatne.

Dbajte na svoju bezpečnosť.

1. Montáž domčeku vykonávajte na suchom mieste a za dobrých poveternostných podmienok
2. Domček montujte v 2-4 ľuďoch.
3. Pri montáži používajte ochranný odev, rukavice a ochranné okuliare.
4. V čase montáže by sa po stavenisku nemali pohybovať deti a domáce zvieratá.

Starostlivosť a údržba:

1. Dvere od domčeku nechávajú zatvorené a zamknuté, aby nedošlo k poškodeniu vplyvom vetra.
2. Domček čistite s pomocou handry a vody.
3. Vždy odstráňte opadané listy zo strechy čo najskôr, aby nedošlo k sfarbeniu strechy. Zo strechy pravidelne odstraňujte napadajúci sneh. Väčšia nános snehu na streche môže spôsobiť poškodenie strechy.
4. Domček nie je určený pre bývanie, ale pre ukladanie vecí. V záhradnom domčeku neskladujte horúce predmety, ako napr. Rozpálený gril, opaľovacie lampy, prchavé chemikálie a pod.

Slovenská verzia návodu je presným prekladom originálneho návodu výrobcu.

Fotografie použité v návode sú len ilustračné a nemusia sa presne zhodovať s výrobkom.



Köszönjük, hogy megvásárolta termékünket.

Használat előtt kérjük olvassa el a használati útmutatót.

Összeszerelési útmutató

Az összeszerelés megkezdése előtt alaposan olvassa el az összes utasítást és információt.

Győződjön meg róla, hogy rendelkezésére áll minden szükséges alkatrész a kerti ház összeszereléséhez.

A házat megfelelően rögzíteni kell az alapszerkezethez, hogy az erős szél ne tegyen kárt benne. Az alapszerkezetet a csomagolás nem tartalmazza, külön kell biztosítani.

Vigyázzon a biztonságára.

1. A kerti házat száraz helyen és jó időjárási körülmények között szerelje össze.
2. A ház összeszereléséhez 2-4 emberre van szükség.
3. Az összeszerelés során használjon védőruházatot, kesztyűt és védőszemüveget.
4. Az összeszereléskor gyermekek és háziállatok nem tartózkodhatnak a helyszínen.

Kezelés és karbantartás

1. A kerti ház ajtaját tartsa zárva, hogy elkerülje a szél okozta károkat.
2. A ház tisztításához használjon rongyot és vizet.
3. Mindig söpörje le a tetőről a ráhullott leveleket a lehető leghamarabb, hogy elkerülje a tető elszíneződését. Rendszeresen távolítsa el a ráhulló havat. A tetőre hullott nagyobb hó károsíthatja a kerti házat.
4. A ház nem alkalmas lakásnak, csak kellékek tárolására. Ne tároljon benne forró tárgyakat, mint pl. forró grill, gázégő, illékony vegyi anyagok stb.

A magyar használati utasítás a gyártótól kapott verzió pontos fordítása.

A kézikönyvben használt fényképek csak illusztrációk, nem egyeznek meg pontosan a termékkel.



Dziękujemy za zakup naszego produktu.

Przed użyciem prosimy starannie przeczytać tę instrukcję.

Instrukcja montażu:

Przed przystąpieniem do montażu należy dokładnie zapoznać się z wszystkimi zaleceniami i informacjami.

Sprawdź, czy posiadasz wszystkie niezbędne elementy do zbudowania altany ogrodowej.

Altana musi być prawidłowo zakotwiona do płyty fundamentowej, aby przy mocno wiejącym wietrze nie doszło do jej uszkodzenia lub zniszczenia. Płyta fundamentowa nie jest elementem zestawu, należy ją wykonać we własnym zakresie.

Dbaj o swoje bezpieczeństwo.

1. Montaż altany ogrodowej przeprowadzić w miejscu suchym i przy sprzyjających warunkach pogodowych.
2. Montaż altany ogrodowej przeprowadzać przy udziale 2-4 osób.
3. Przy montażu należy użyć odzieży ochronnej, rękawic i okularów ochronnych.
4. Podczas trwania montażu na placu budowy nie powinny przebywać dzieci i zwierzęta domowe.

Pielęgnacja i konserwacja:

1. Drzwi altany ogrodowej pozostawiać w stanie zamkniętym i zabezpieczonym zamkniętym zamkiem, aby uniknąć uszkodzeń spowodowanych na skutek działania wiatru.

2. Altanę ogrodową czyścić używając ścierek i wody.

3. Zawsze, jak najprędzej, należy usuwać opadłe liście z dachu, aby nie powodowały wystąpienia przebarwień na dachu. Z dachu należy regularnie usuwać śnieg. Grubsza warstwa okrywy śniegowej może spowodować uszkodzenie dachu.

4. Altana ogrodowa nie jest przeznaczona do zamieszkania, służy do przechowywania rzeczy. W altanie ogrodowej nie składować przedmiotów gorących, jak np. rozpalony grill, lampy do opalania, lotne chemikalia, itp.

Installation

Montage

Montáž

Összeszerelés

Montaż



Tools you will need / Werkzeuge, die Sie brauchen / Nástroje, které budete potřebovat
 Nástroje, které budete potřebovat / Szükséges eszközök és szerszámok / Przyrządy
 i narzędzia, które będą potrzebne

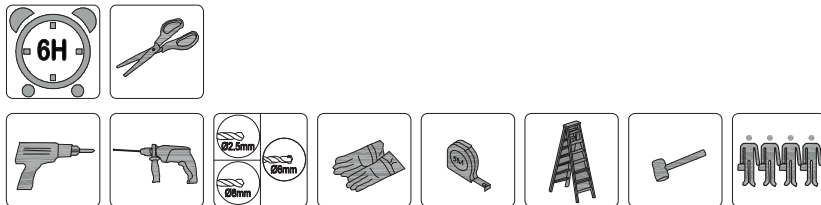

Dimensions \ Abmessungen \ Rozměry \ Rozmery \ Méretek \ Wymiary

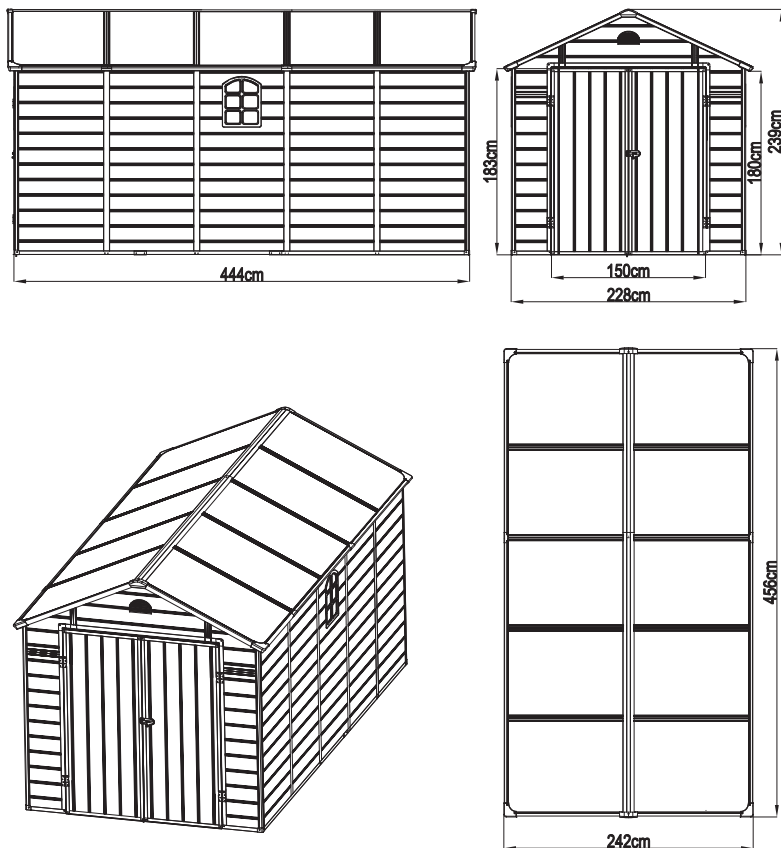





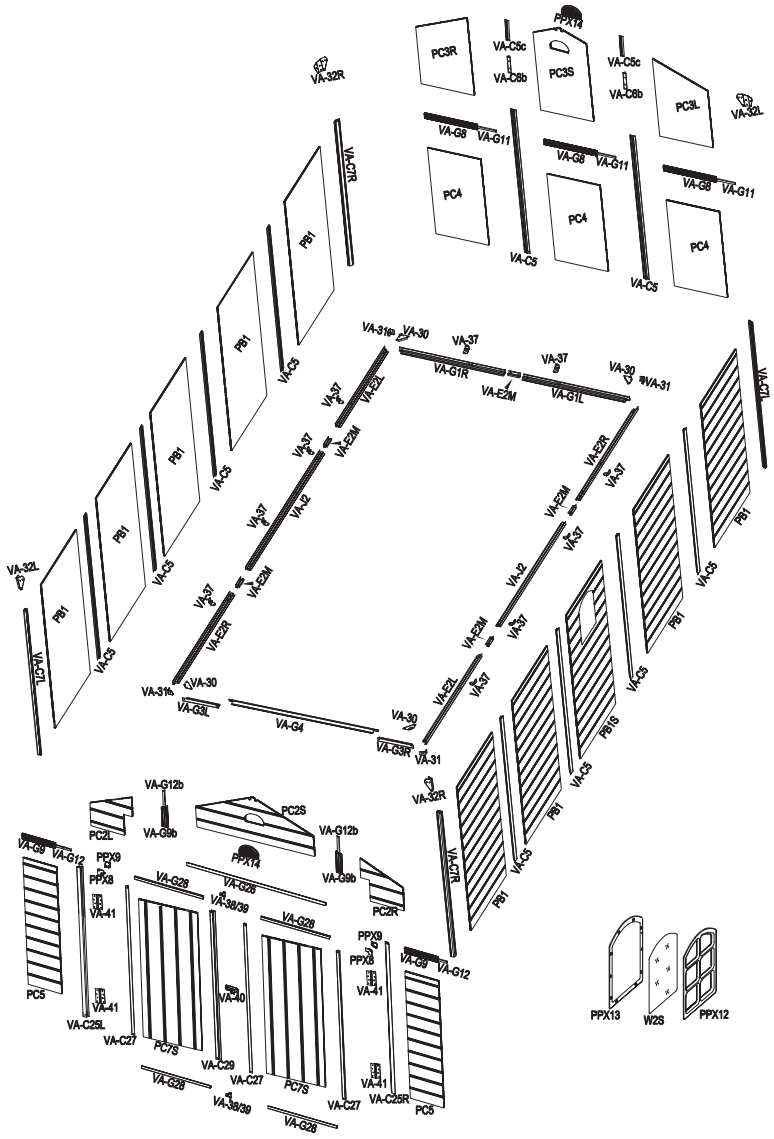

Parts list \ Teilliste \ Seznam dílů \ Zoznam dielov \ Alkatrész lista \ Wykaz części





VA-G1L		1132mm	x1	3/3
VA-G1R		1132mm	x1	3/3
VA-J2		1760mm	x2	3/3
VA-E2R		1330mm	x2	3/3
VA-E2L		1330mm	x2	3/3
VA-G3R		377mm	x1	3/3
VA-G3L		377mm	x1	3/3
VA-E2M		120mm	x5	3/3
VA-G4		1588mm	x1	3/3
VA-30			x8	2/3
VA-31			x4	2/3
VA-37			x10	2/3
PB1		876x1840mm	x9	1/3
PB1S		876x1840mm	x1	1/3
PC2S		1270x542mm	x1	2/3
PC2L		461x493mm	x1	2/3
PC2R		461x493mm	x1	2/3
PC3L		743X1072mm	x1	1/3
PC3R		743X1072mm	x1	1/3
PC3S		743X1248mm	x1	2/3
PC4		743X1100mm	x3	2/3
PC5		365X1548mm	x2	1/3
VA-C7R		1860mm	x2	1/3
VA-C7L		1860mm	x2	1/3
VA-C5		1840mm	x10	3/3
VA-C5c		365mm	x2	3/3
VA-C6b		200mm	x2	3/3
PPX12			x1	2/3
W2S			x1	2/3
PPX13			x1	2/3
VA-G8		738mm	x3	2/3
VA-G9		360mm	x2	2/3
VA-G9b		254mm	x2	2/3
VA-G11		740mm	x3	3/3
VA-G12		362mm	x2	3/3
VA-G12b		225mm	x2	3/3
VA-G14b		1200mm	x1	3/3
VA-G14c		1052mm	x1	3/3
VA-G14AL		345mm	x1	3/3
VA-G14AR		345mm	x1	3/3
VA-H15		970mm	x2	3/3
VA-F16		1678mm	x2	3/3
VA-J16		1805mm	x2	3/3
VA-E17		977mm	x2	3/3
VA-E18		1745mm	x2	3/3
VA-J18		1805mm	x2	3/3
VA-G19		1181mm	x8	3/3
VA-D20		725mm	x4	3/3
VA-33			x8	3/3
VA-34			x4	3/3
VA-E23		1348mm	x2	3/3

VA-J23		1780mm	x1	3/3
VA-36			x2	2/3
VA-32R			x2	2/3
VA-32L			x2	2/3
VA-35			x2	2/3
PPX14			x2	2/3
PPX8			x2	2/3
PPX9			x2	2/3
VA-43			x2	2/3
PC6-C		1285X920mm	x4	2/3
PC6-M		1285X856mm	x6	2/3
VA-G10		1285mm	x8	2/3
VA-G13		1285mm	x8	3/3
VA-G21		1165mm	x4	2/3
VA-E22		1282mm	x4	3/3
VA-J22		1740mm	x2	3/3
VA-E24		1440mm	x2	3/3
VA-J24		1861mm	x1	3/3
VA-E41		983mm	x2	3/3
VA-F42		1862mm	x2	3/3
VA-J41		1862mm	x2	3/3
PPX3			x4	2/3
PPX4			x2	2/3
PPX11			x4	2/3
VA-C25R		1830mm	x1	3/3
VA-C25L		1830mm	x1	3/3
VA-G26		1508mm	x1	3/3
VA-C27		1812mm	x3	3/3
VA-G28		747mm	x4	3/3
VA-C29		1812mm	x1	3/3
PC7S		1810x746mm	x2	1/3
VA-41			x4	2/3
VA-38a			x2	2/3
VA-38b			x2	2/3
VA-39			x2	2/3
VA-40			x1	2/3
CN-A33			x2	2/3
PA01			x3	2/3
VA-J44		ST4.2x13mm	x510	2/3
VA-J45		ST4.2x19mm	x137	2/3
VA-J46		ST4.2x13mm	x83	2/3
VA-J47		ST4.2x19mm	x4	2/3
VA-J48		ST6.0x40mm	x19	2/3
VA-J49		ST4.2x13mm	x26	2/3
VA-J50		M6x40mm	x40	2/3
VA-51			x1	2/3
VA-J52			x4	2/3
VA-53			x4	2/3

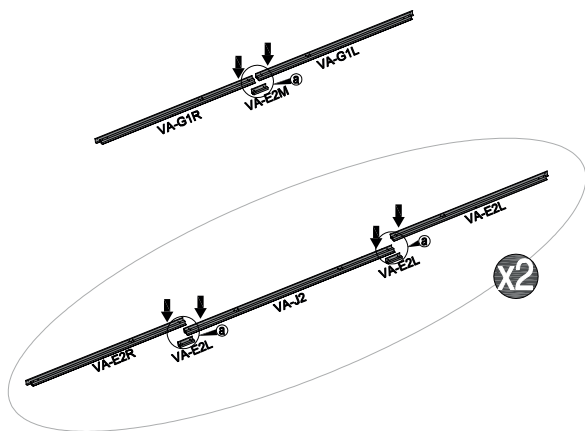
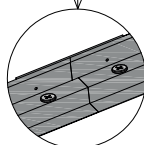
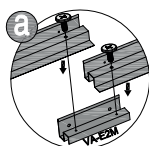
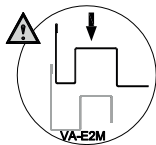

1	 VA-E2L [x2] 1330mm	 VA-E2R [x2] 1330mm	 VA-I2 [x2] 1780mm	 VA-G1R [x1] 1132mm	 VA-G1L [x1] 1132mm	 VA-E2M [x2] 120mm	 VA-I44 [x10] 13mm	
----------	--	--	---	--	--	---	---	--



2	 VA-G3L [x1] 377mm	 VA-G3R [x1] 377mm	 VA-G4 [x1] 198mm	 VA-I44 [x4] 13mm	
----------	---	---	--	--	--

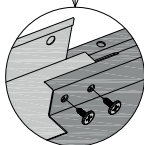
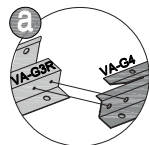
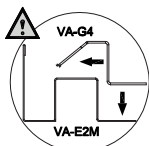



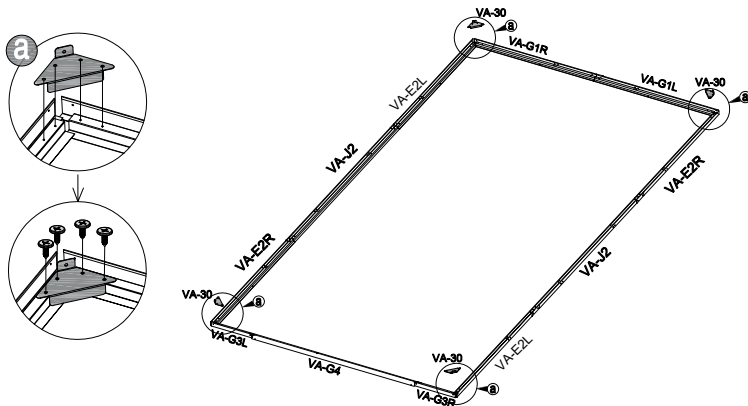

3	 VA-30 [x4]	 VA-J44 [x18] 13mm
----------	---	---

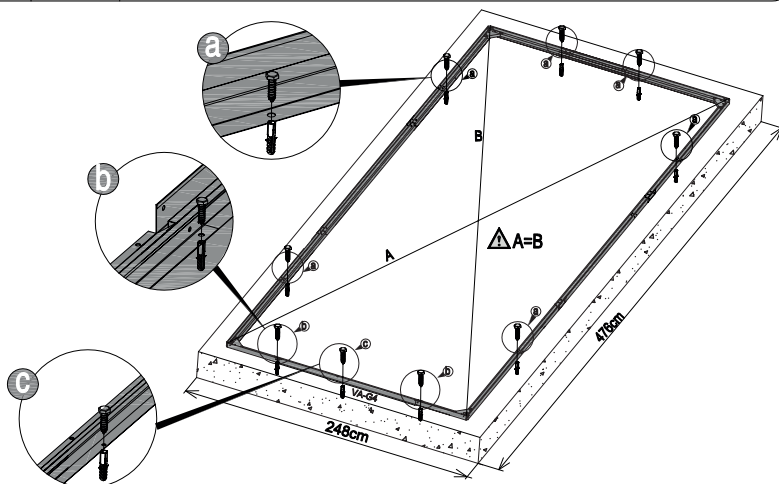

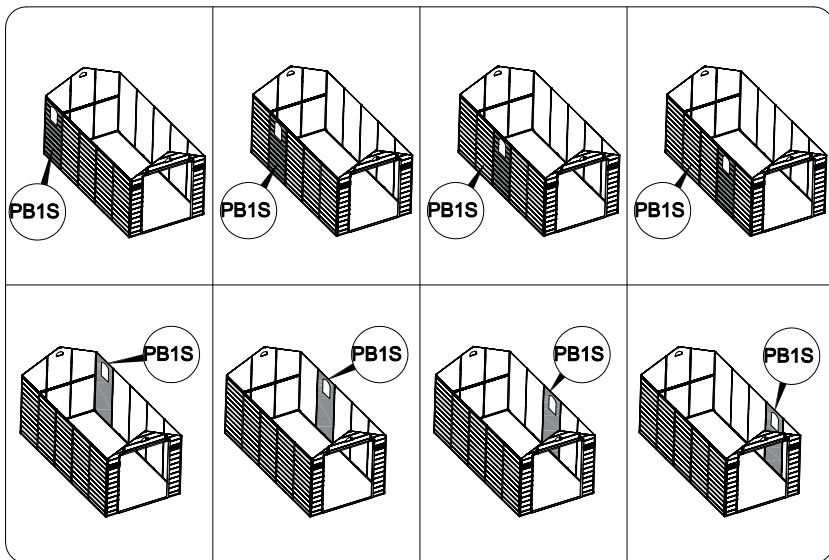

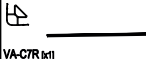

4	 VA-J48 [x8] 40mm
----------	--



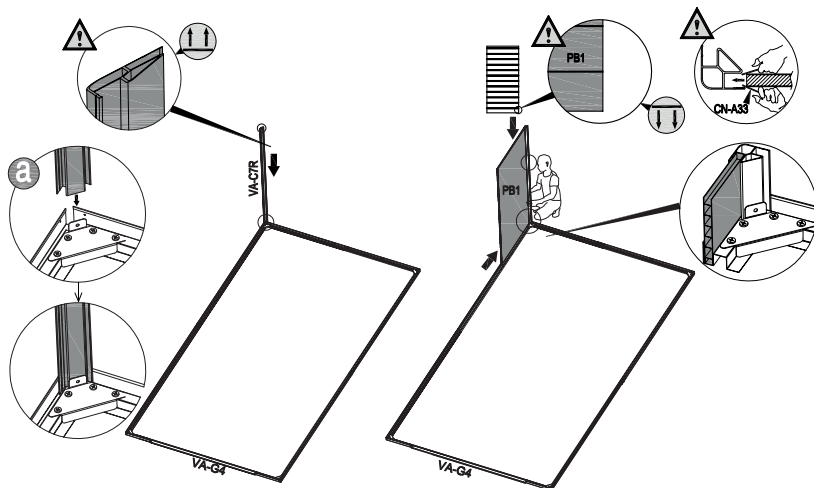





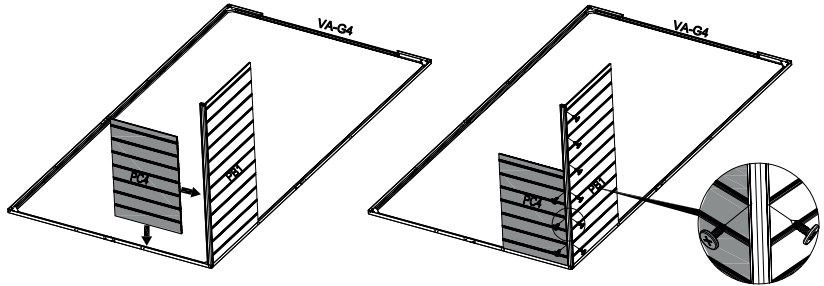

<p>5</p>	<p>PB1 (x1) 876x190mm</p> 	<p>VA-C7R (x1) 190mm</p> 	 <p>CN-A33</p>	
-----------------	---	--	---	---





6	 PC4 [x1] 743x1100mm	 VA-J45 [x8] 18mm	 CN-A33	
----------	---	--	---	---



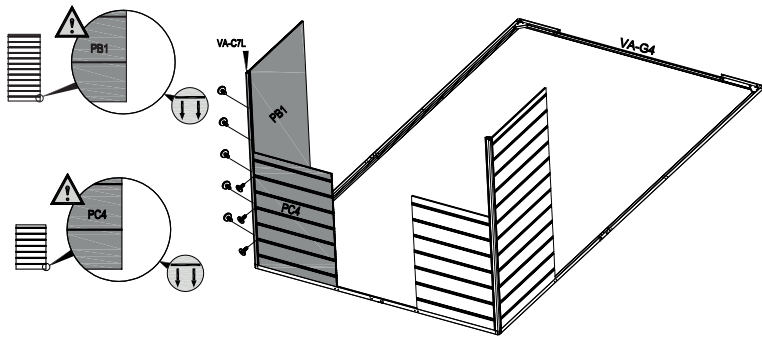
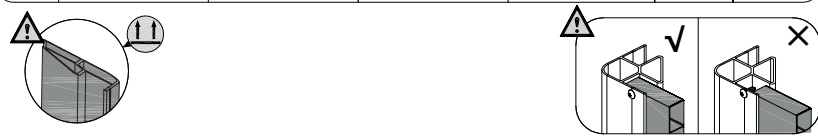



7	 VA-CTL [x1] 1680mm	 PB1 [x1] 878x1640mm	 PC4 [x1] 743x1100mm	 VA-J45 [x8] 18mm	 CN-A33	
----------	--	---	---	--	---	---

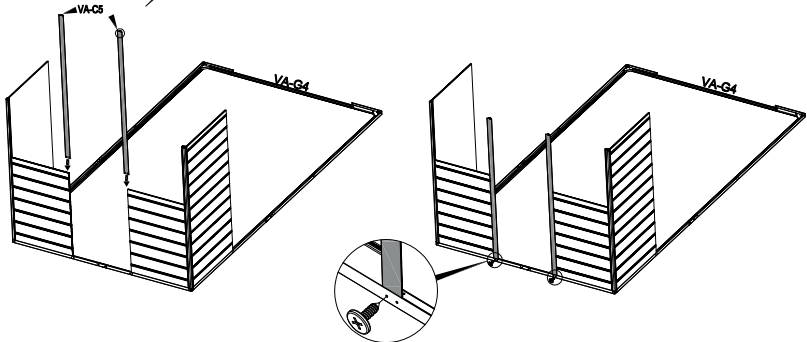
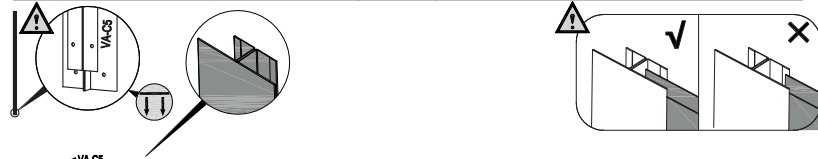





8	 VA-C5 [x2] 1840mm	 VA-J44 [x2] 13mm	 CN-A33	
----------	---	--	---	--

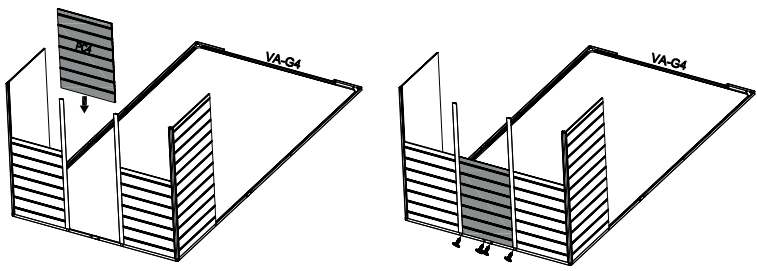

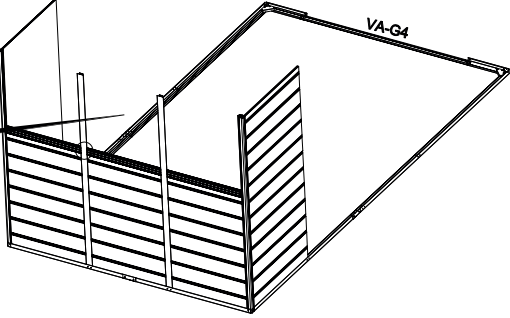
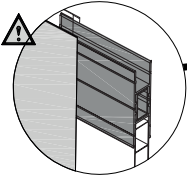
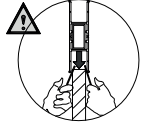
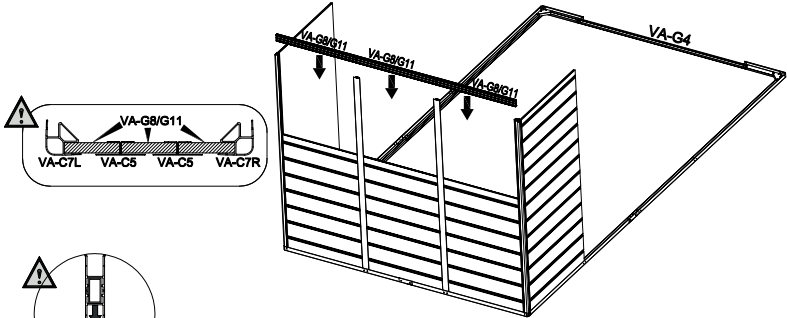
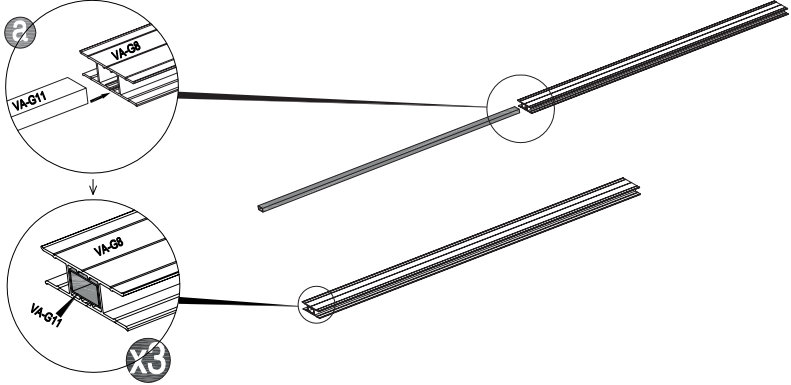
9	 PC4 [x1] 763x1100mm	 VA-J44 [x4] 13mm	 CN-A33	
----------	---	--	---	---







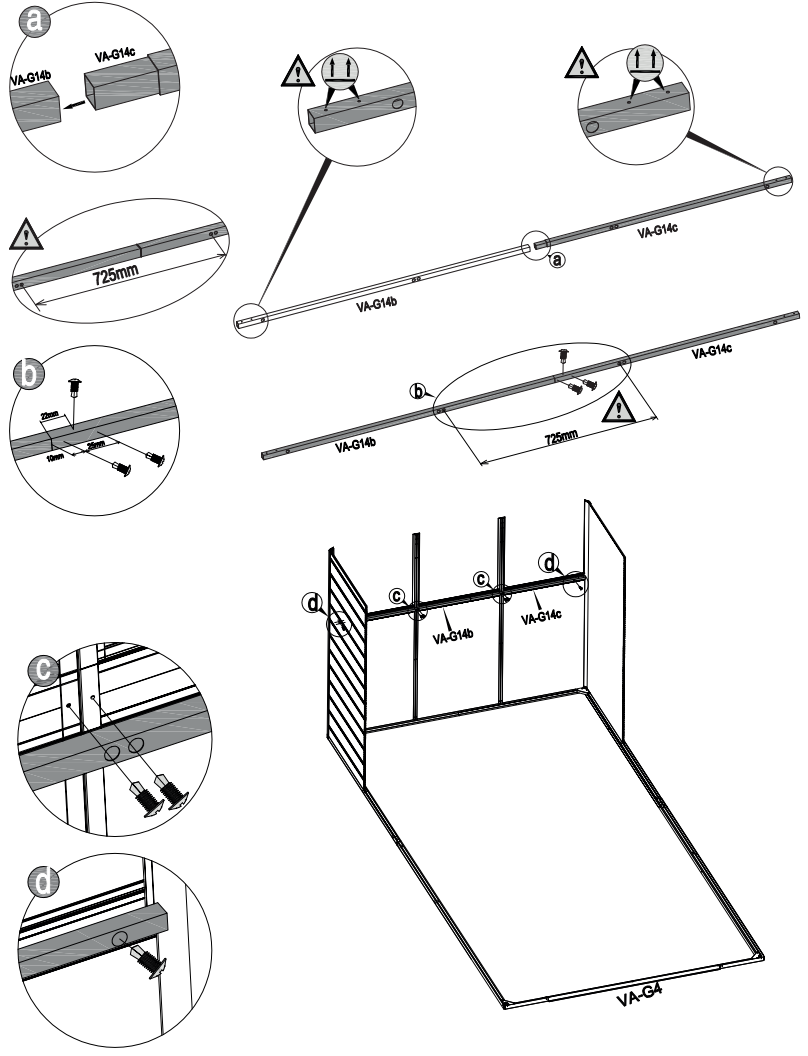

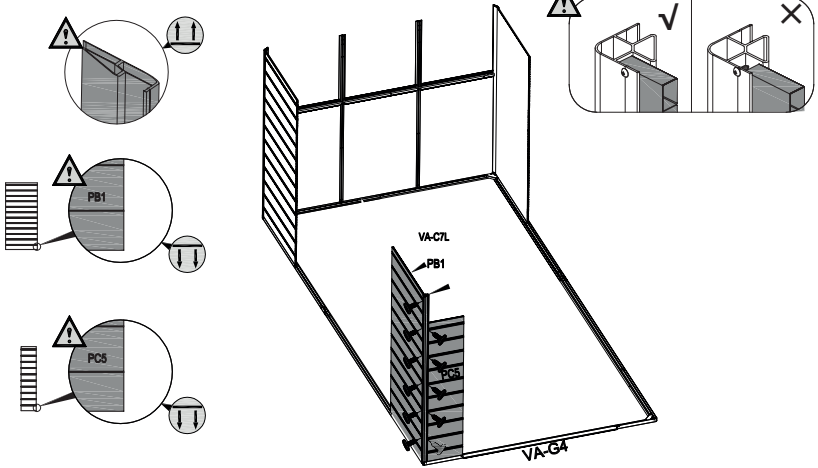

11	 VA-G14b [p1] 1200mm	 VA-G14c [p1] 1052mm	 VA-M6 [p9] 13mm				
-----------	---	---	---	--	--	--	--



12	 VA-C7L [x1] 1880mm	 PB1 [x1] 87x1840mm	 PC5 [x1] 385x1548mm	 VA-J45 [x11] 16mm	 CN-A33	
-----------	--	--	---	---	---	---



13	 VA-C7R [x1] 1880mm	 PB1 [x1] 87x1840mm	 PC5 [x1] 385x1548mm	 VA-J45 [x11] 16mm	 CN-A33	
-----------	--	--	---	---	---	---

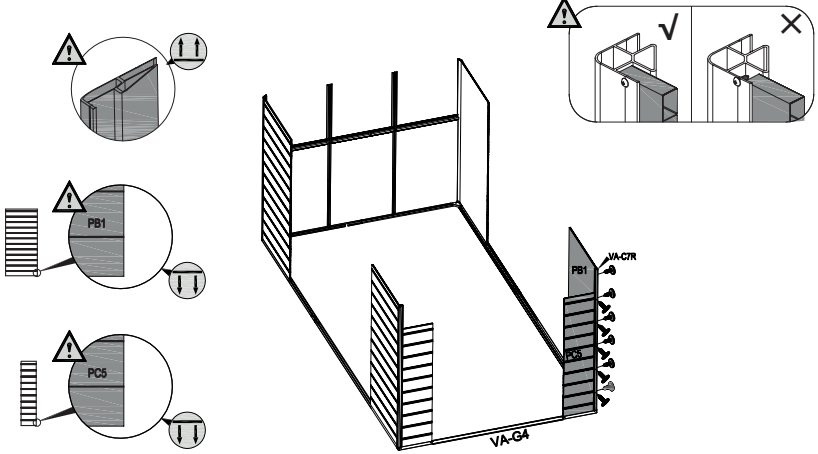

14



VA-31 [4]



VA-J44 [4]
13mm

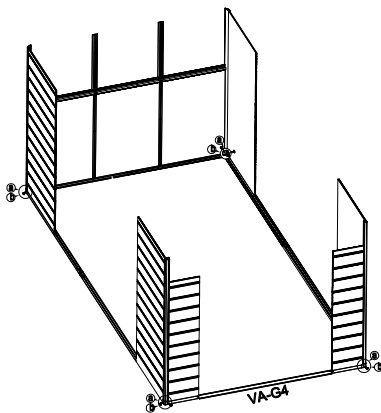
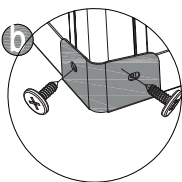
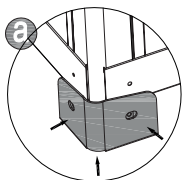

15



VA-J44 [4]
13mm

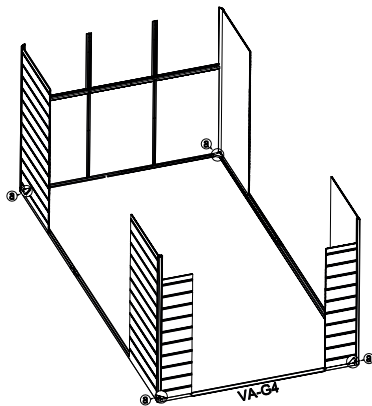
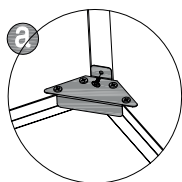

16	VA-C5 [x4] 1840mm	VA-J44 [x4] 13mm	CN-A33	
----	----------------------	---------------------	--------	--

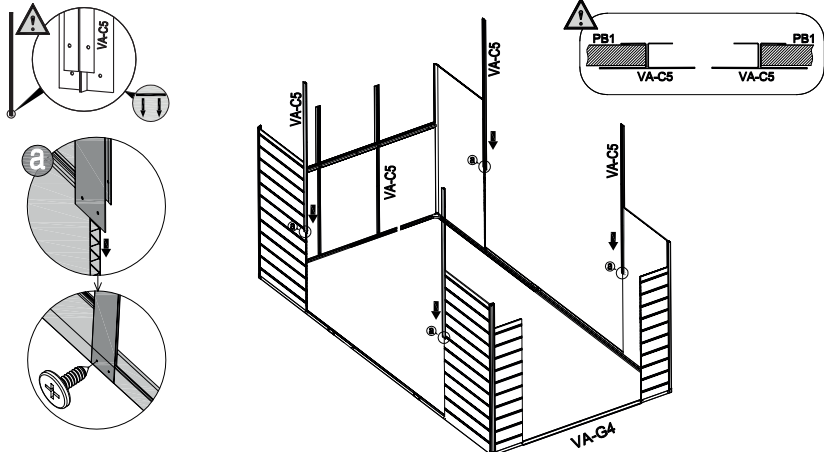

17	VA-F16 [x2] 1872mm	VA-H15 [x2] 870mm	VA-J16 [x2] 1825mm	VA-J46 [x12] 13mm	
----	-----------------------	----------------------	-----------------------	----------------------	--

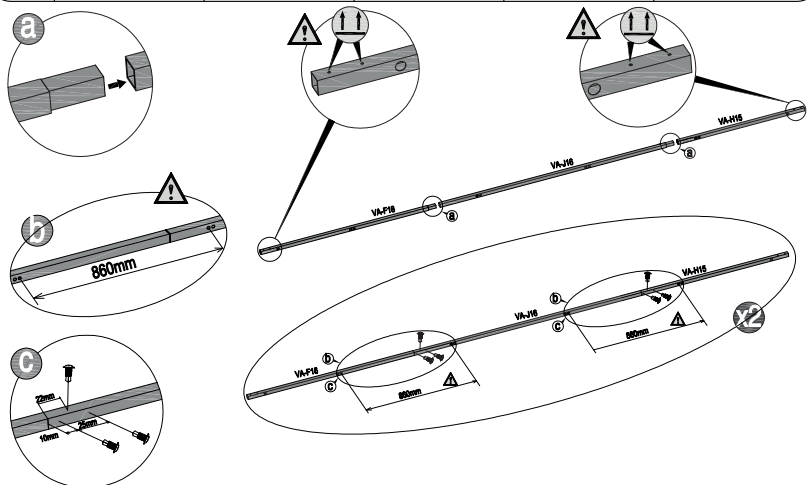

18



VA-30 [x2]







VA-M4 [x10]
13mm

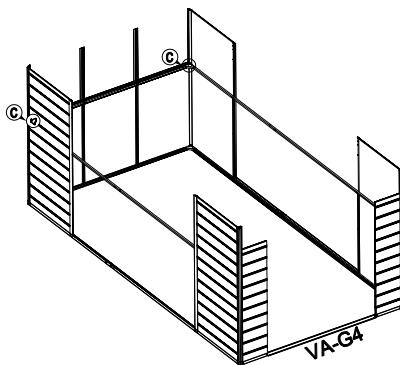
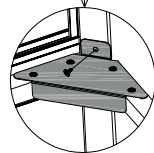
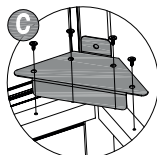
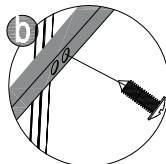
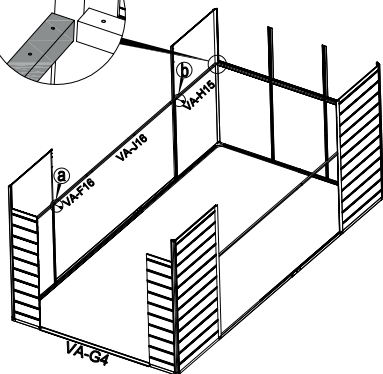
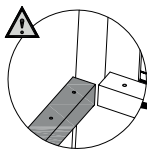
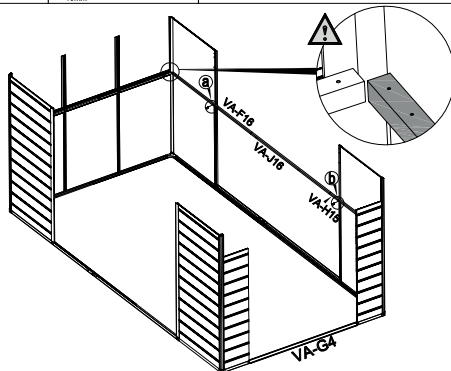
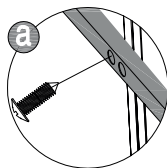





VA-J49 [x1]
13mm



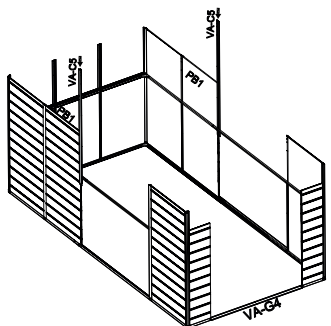
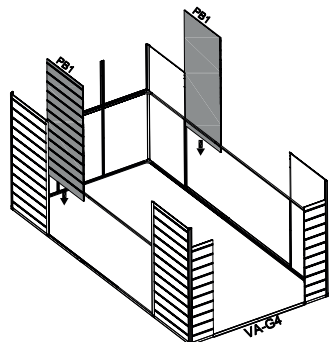
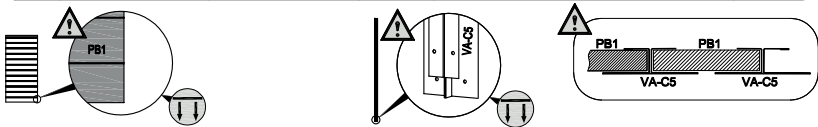



11

19	 PB1 [x2] 878x194mm	 VA-C5 [x2] 194mm	 CN-A33	
-----------	--	--	---	---

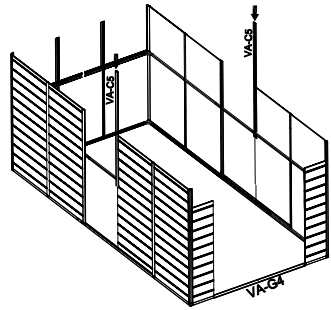
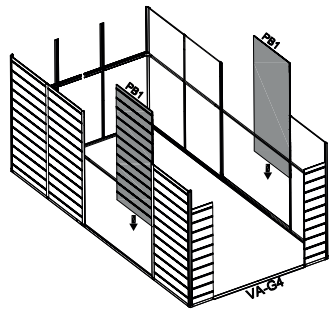
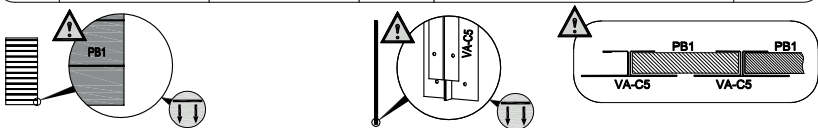

20	 PB1 [x2] 878x194mm	 VA-C5 [x2] 194mm	 CN-A33	
-----------	--	--	---	---



21	 PB1 (x1) 678x164mm	 PB1S (x1) 678x164mm	 CN-A33	
-----------	--	---	---	---

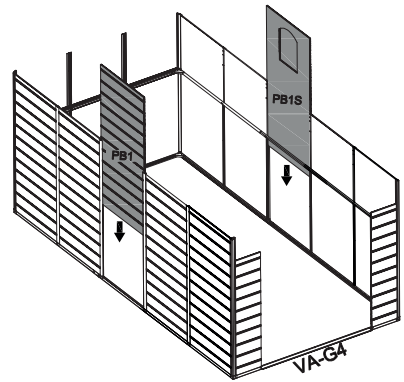
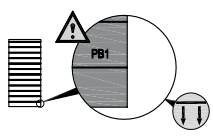
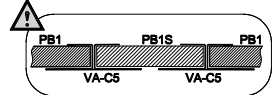
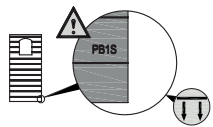



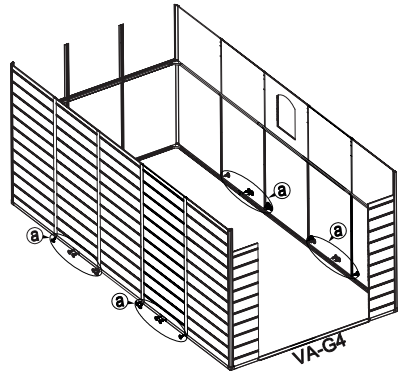
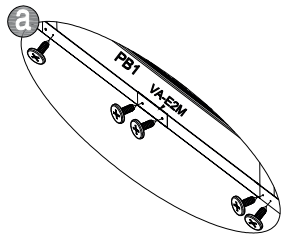

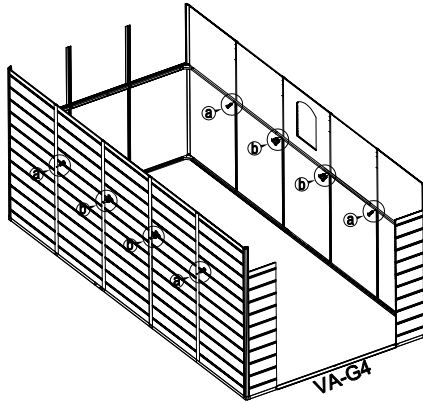
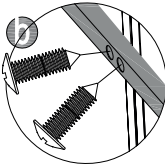
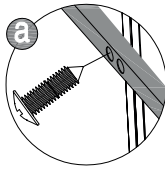

22	 VA-M4 (x20) 13mm	
-----------	--	---





23	 VA-J49 [x12] 13mm
-----------	--



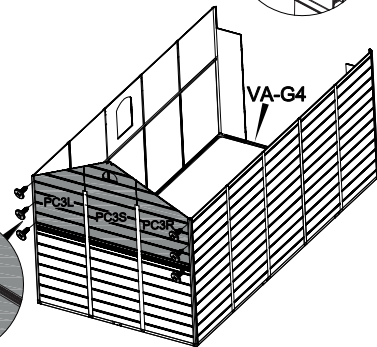
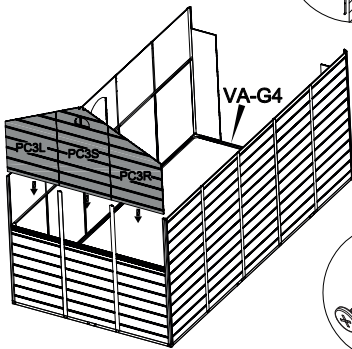
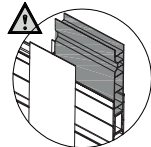
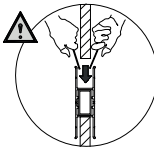
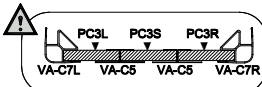

24	 PC3L [x1] 743x1072mm	 PC3R [x1] 743x1072mm	 PC3S [x1] 743x1246mm	 VA-J46 [x6] 10mm	 CN-A33	
-----------	---	---	---	---	--	---



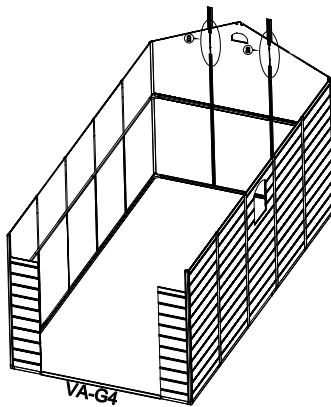
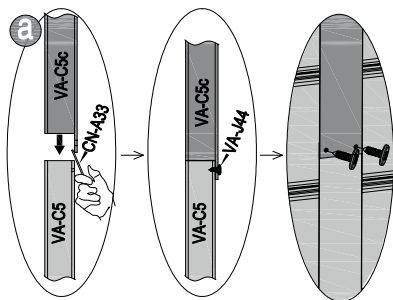
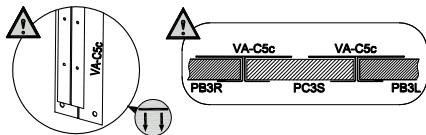



25	 <p>VA-C5c (p4) 355mm</p>	 <p>VA-M4 (p4) 13mm</p>	 <p>CN-A33</p>	
-----------	--	--	---	--

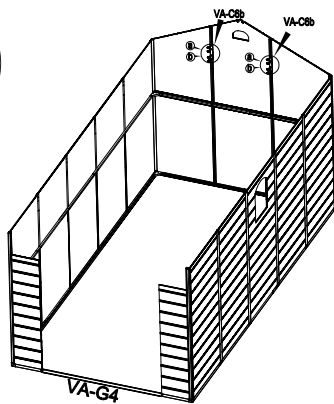
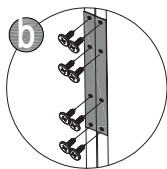
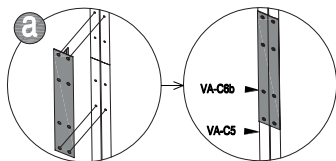

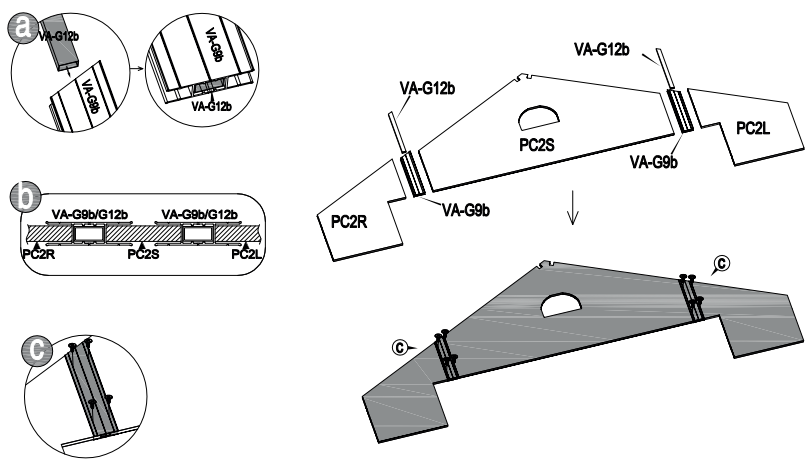
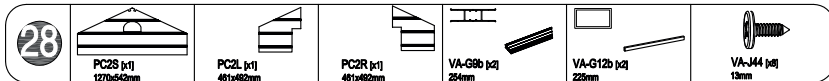
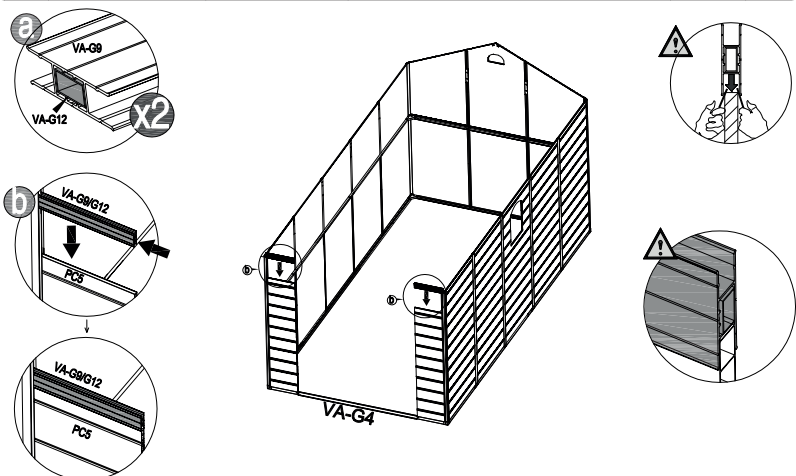



26	 <p>VA-C6b (p2) 200mm</p>	 <p>VA-M4 (k18) 13mm</p>		
-----------	--	---	--	--



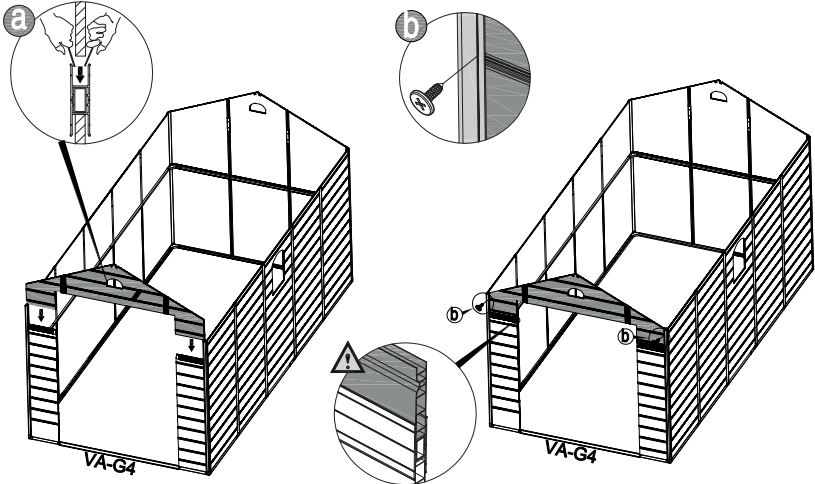





29	 VA-J45 [x2] 13mm	 CN-A33		
----	--	---	---	---

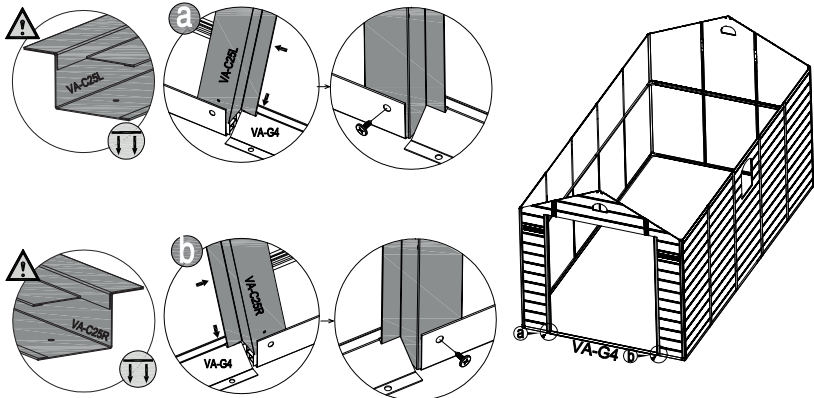

30	 VA-C25L [x1] 1830mm	 VA-C25R [x1] 1830mm	 VA-J44 [x2] 13mm
----	---	---	--

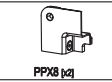
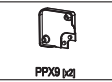
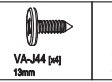
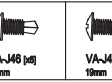



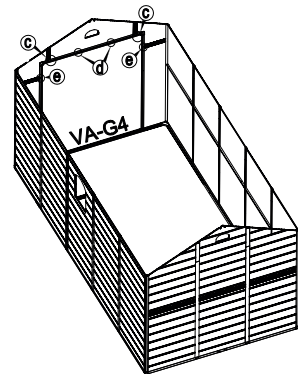
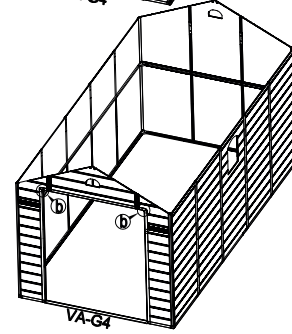
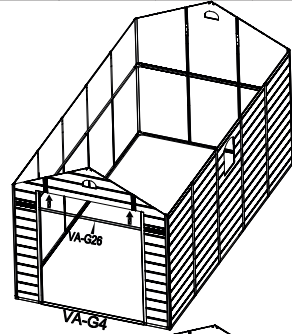
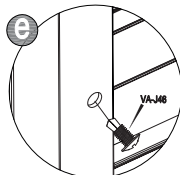
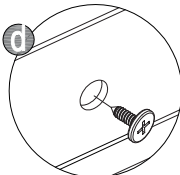
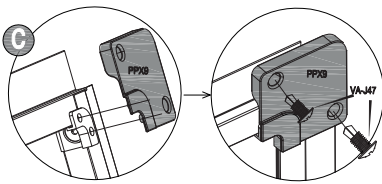
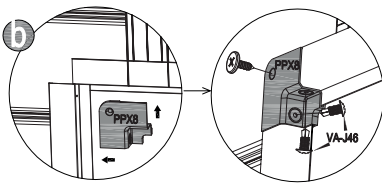
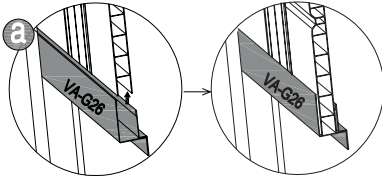

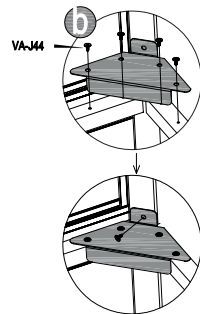
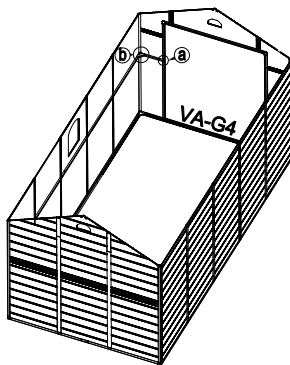
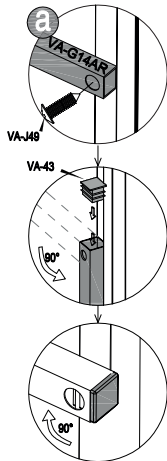
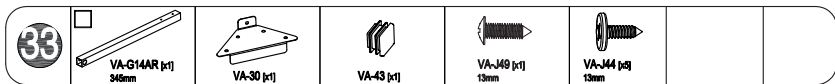
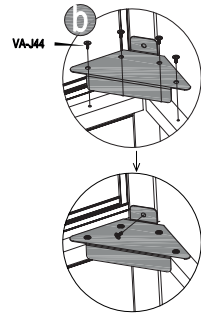
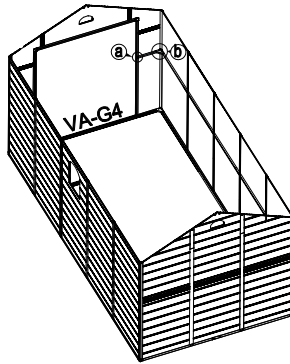
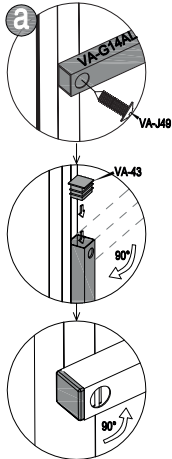
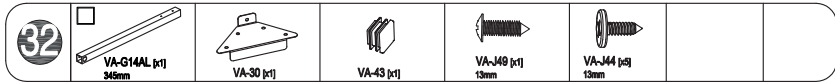

31	 <p>VA-G26 (x1) 150mm</p>	 <p>PPX8 (x2)</p>	 <p>PPX9 (x2)</p>	 <p>VA-J44 (x4) 13mm</p>	 <p>VA-J46 (x6) 13mm</p>	 <p>VA-J47 (x4) 13mm</p>
----	--	--	--	---	---	---

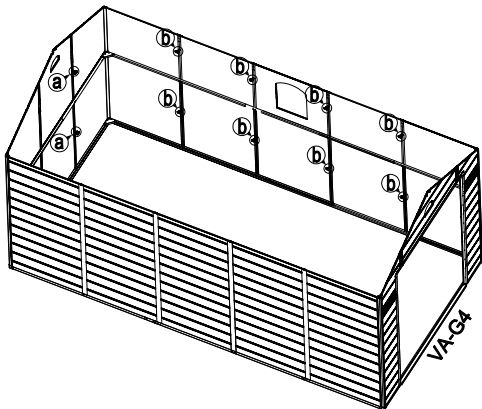
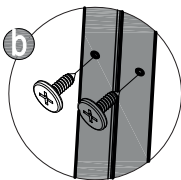
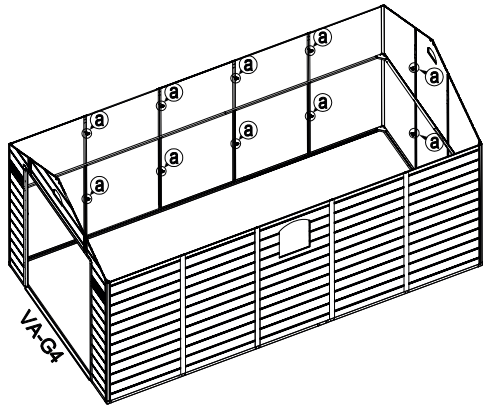
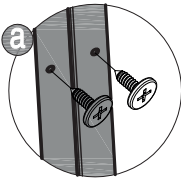







34

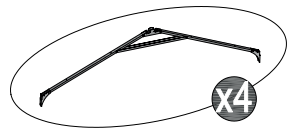
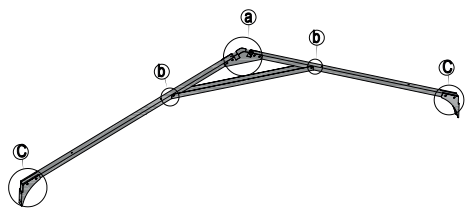
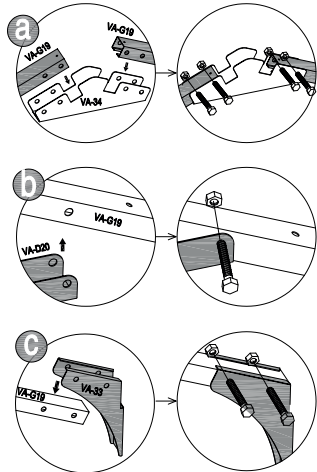



35	 VA-34 [x4]	 VA-33 [x4]	 VA-G19 [x4] 1181mm	 VA-D20 [x4] 729mm	 VA-J50 [x4] 40mm	
-----------	---	---	--	---	--	--

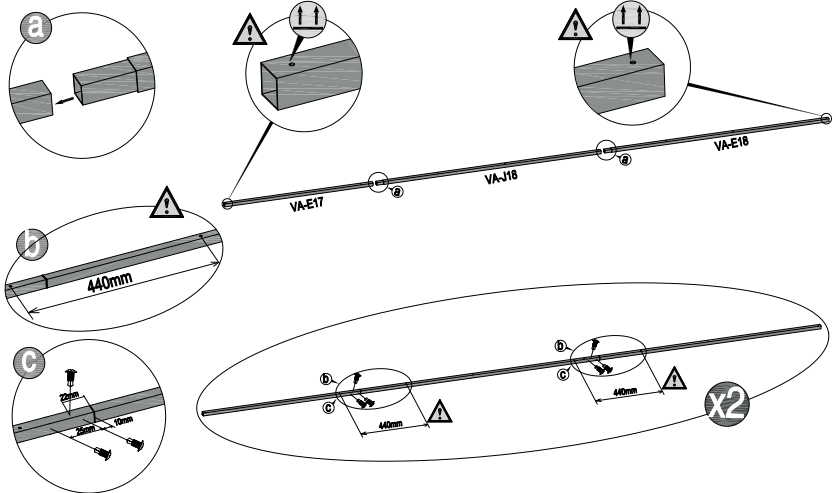

36	 VA-E17 [x2] 877mm	 VA-E18 [x2] 1745mm	 VA-J18 [x2] 1805mm	 VA-J46 [x2] 13mm	
-----------	---	--	--	--	--





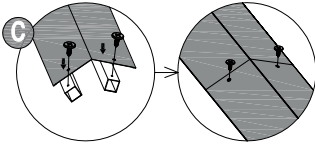
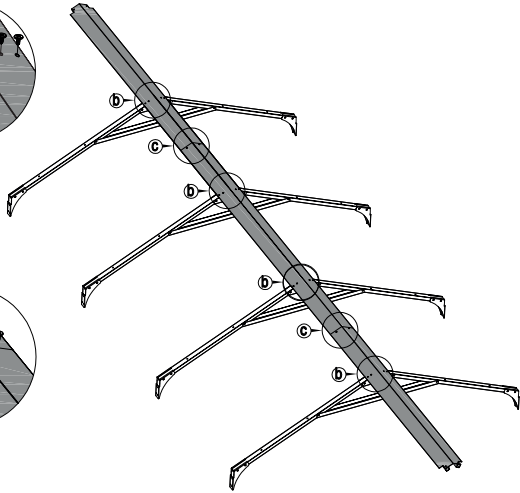
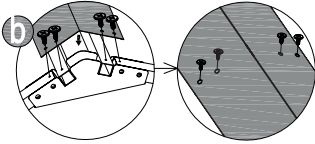
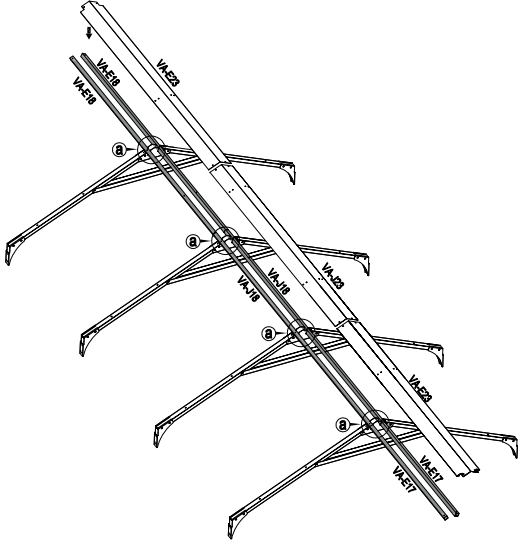
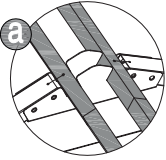

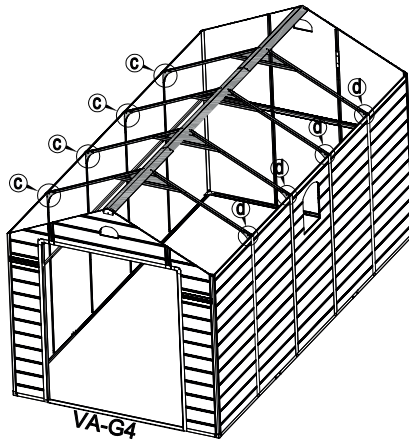
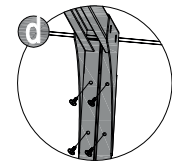
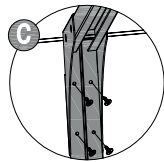
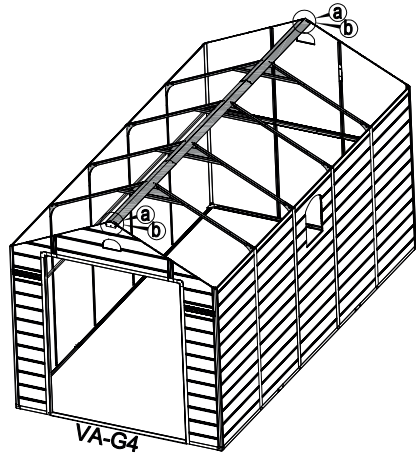
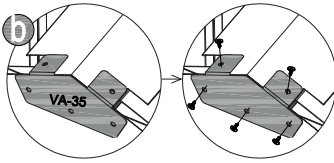
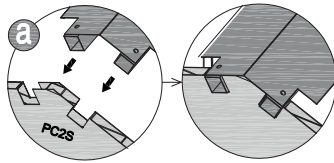

<p>37</p>	 <p>VA-E23 (x2) 1540mm</p>	 <p>VA-J23 (x1) 1780mm</p>	 <p>VA-J44 (x20) 12mm</p>	
------------------	---	---	--	--



38	 VA-35 [x2]	 VA-J44 [x42] 13mm		
----	---	---	---	---



39	 PC8-M [ø] 128x400mm	 PC8-C [ø] 128x400mm	 VA-G10 [ø] 128mm	 VA-G13 [ø] 128mm	 VA-M4 [ø] 13mm		 CN-A33
----	---	---	--	--	--	--	---

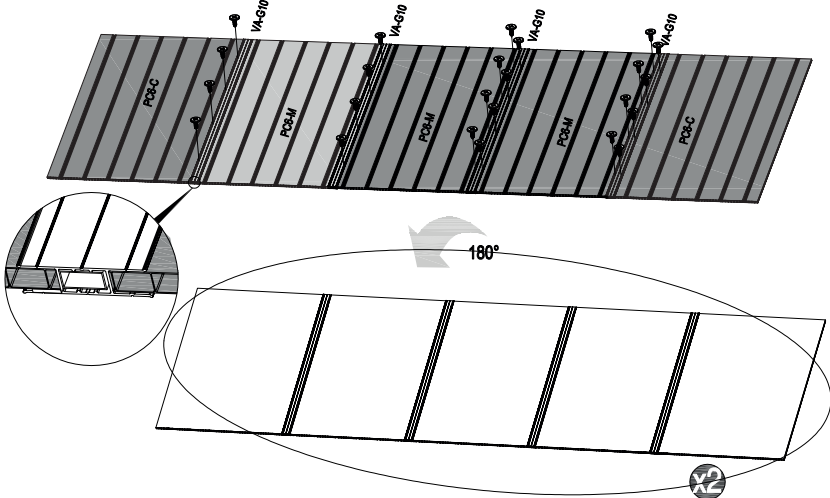
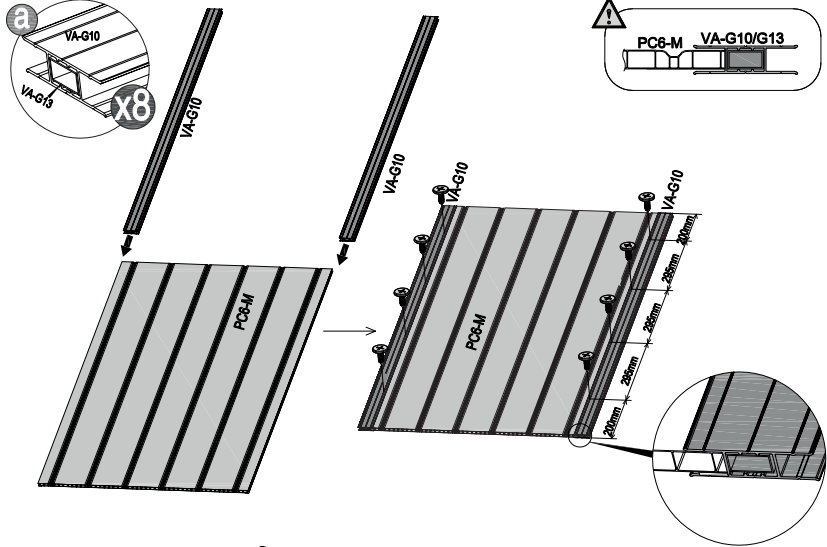

40	 VA-53 [x4]	 VA-J44 [x4] 13mm	 CN-A33
-----------	----------------	-------------------------	------------

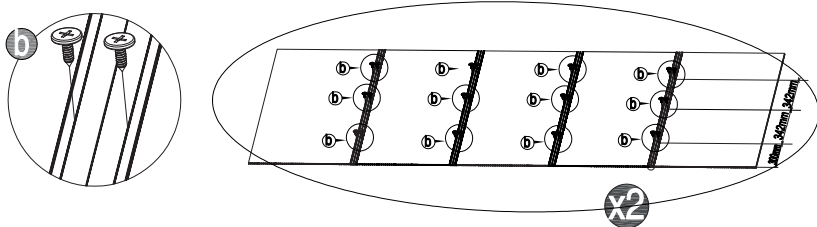
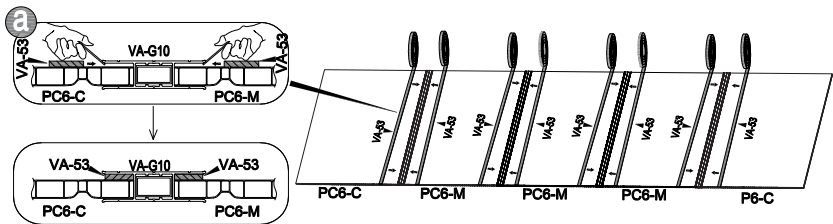

41	 VA-E22 [x4] 1282mm	 VA-J22 [x2] 1740mm	 Ø8mm
-----------	---------------------------	---------------------------	----------



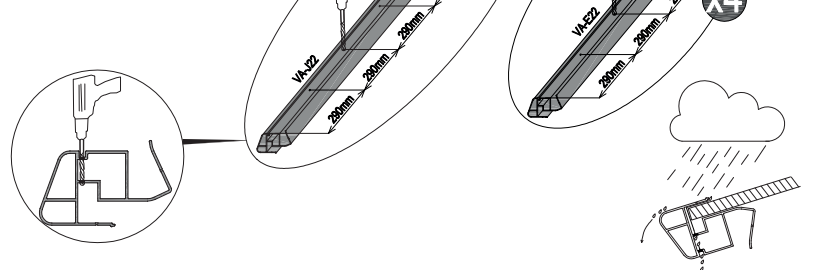

 VA-E22 [x4] ✓ 1282mm	VA-G21 [x4] ✗ 1165mm
VA-J22 [x2] ✓ 1740mm	

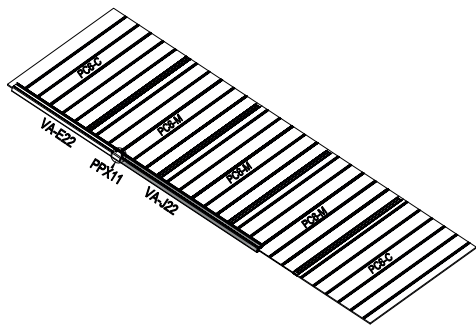
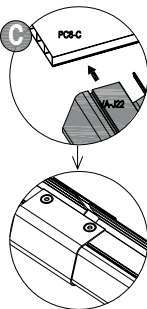
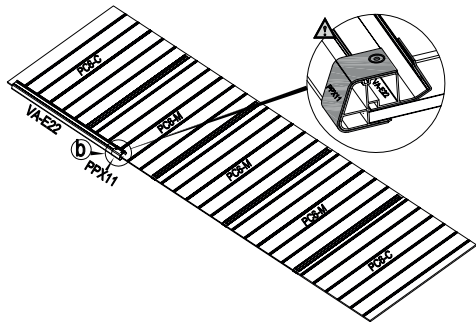
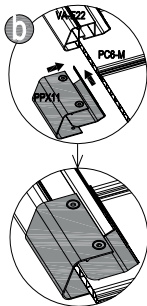
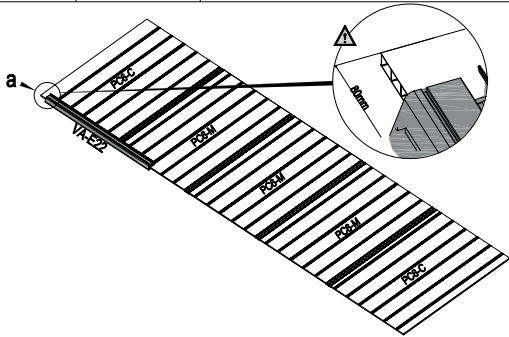
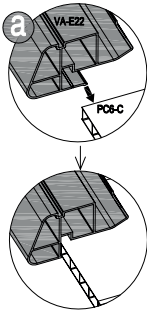

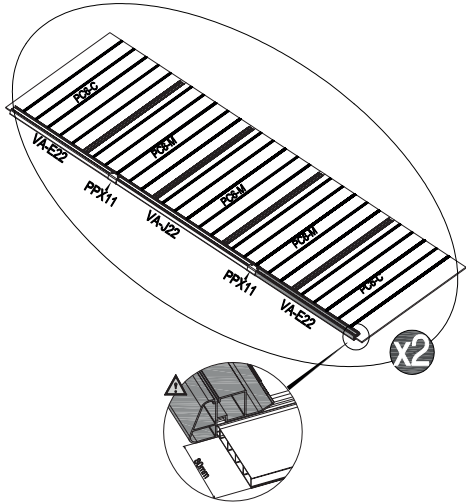
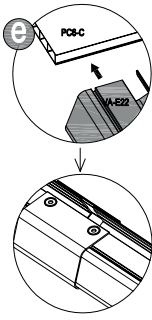
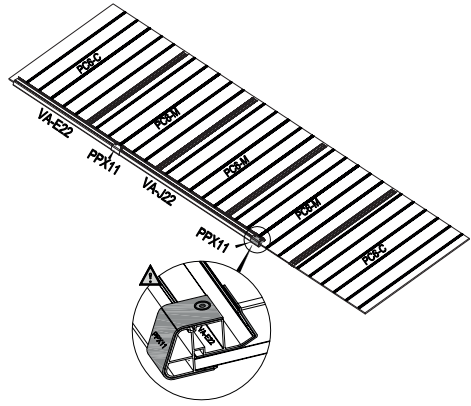
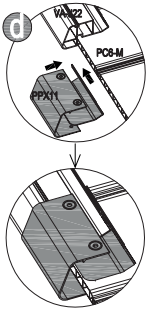





42	 VA-E22 [m] 1262mm	 VA-J22 [m] 1740mm	 PPX11 [m]	 CN-A33
				

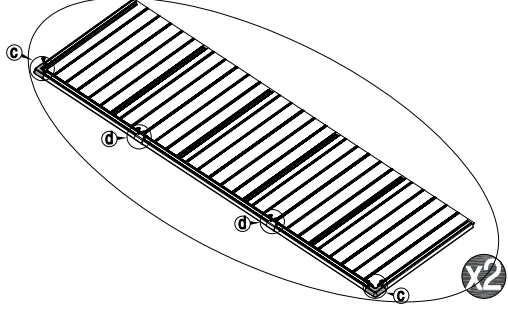
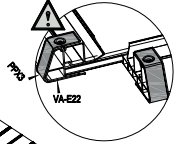
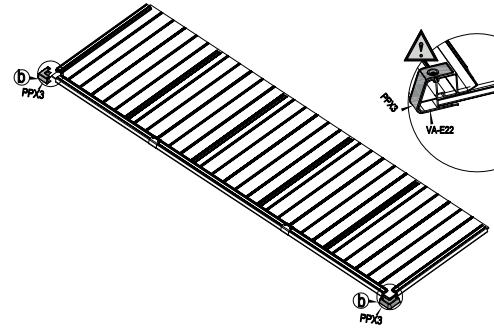
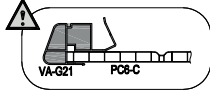
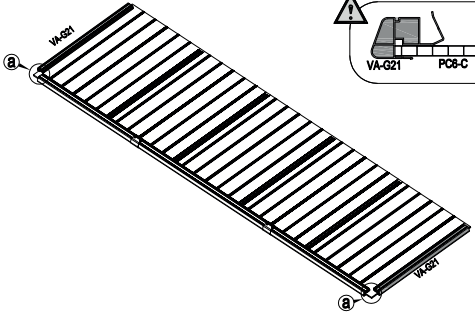
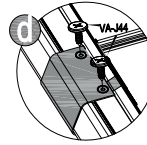
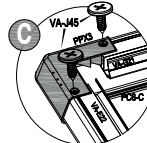
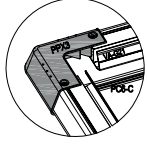
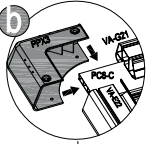
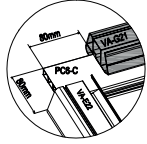
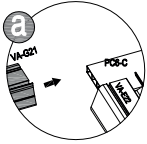

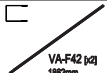

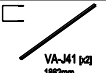
<p>43</p>	 <p>VA-G21 [x4] 1165mm</p>	 <p>PPX3 [x4]</p>	 <p>VA-J44 [x4] 13mm</p>	 <p>VA-J45 [x4] 13mm</p>		 <p>CN-A33</p>
------------------	---	--	---	---	--	---



44	 VA-F42 [x2] 182mm	 VA-E41 [x2] 95mm	 VA-M1 [x2] 182mm	 VA-J45 [x3] 19mm	 VA-J46 [x18] 13mm	 VA-J44 [x18] 13mm	 CN-A33
-----------	--	---	---	---	--	--	--

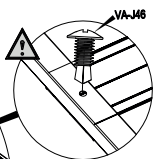
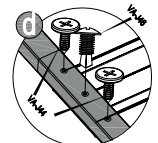
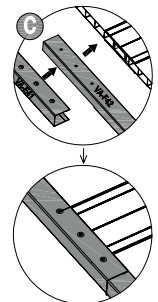
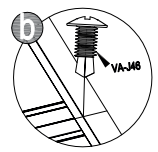
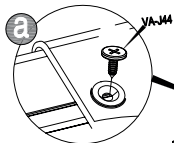
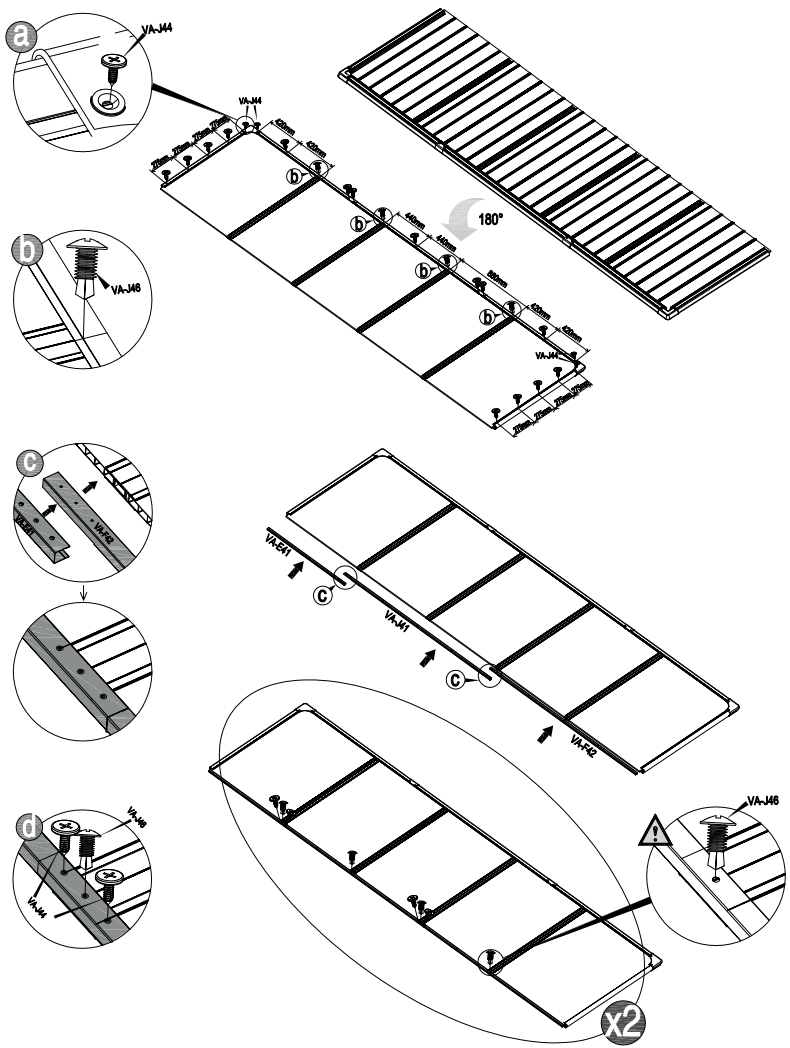

x2

45	 CN-A33		
----	---	---	---

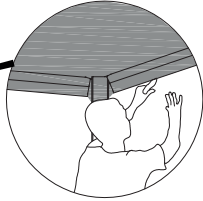
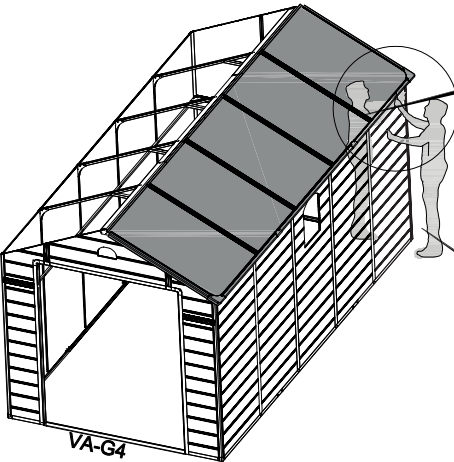
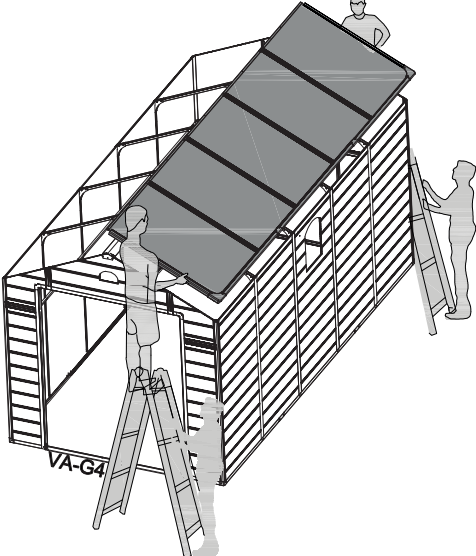
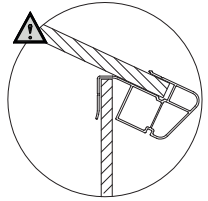
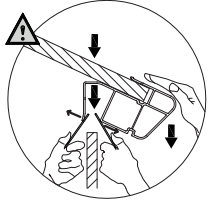

46





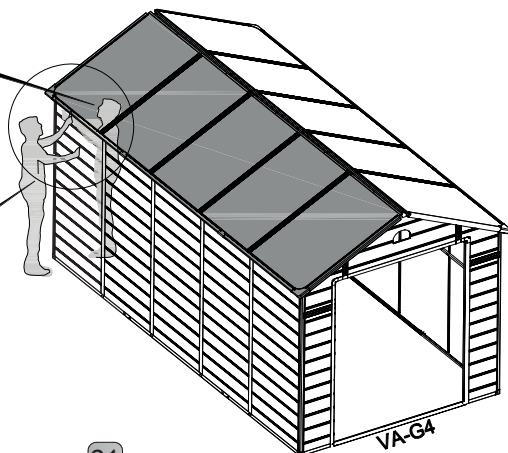
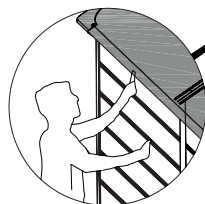
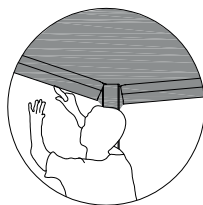
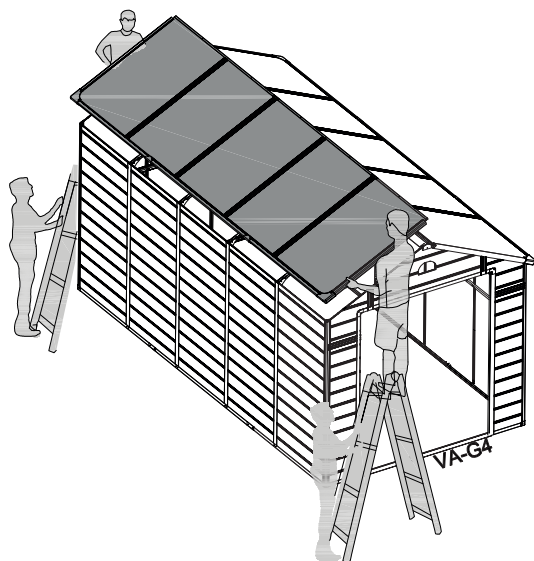
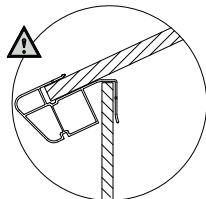
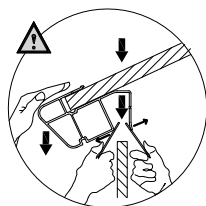

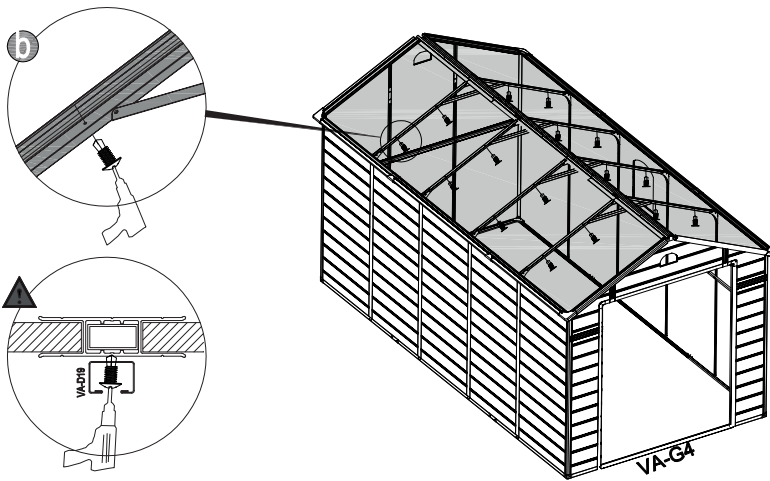
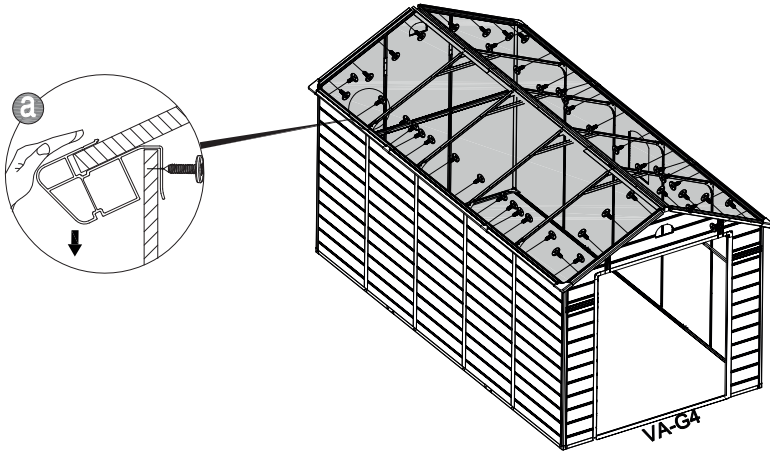

CN-A33







47	 VA-J45 p44 16mm	 VA-J46 p19 13mm
----	---	---

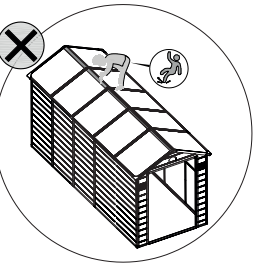
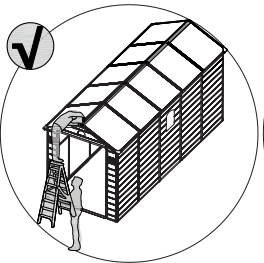
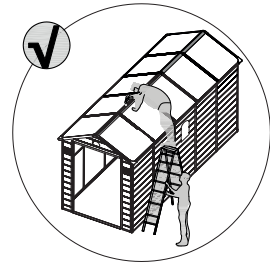
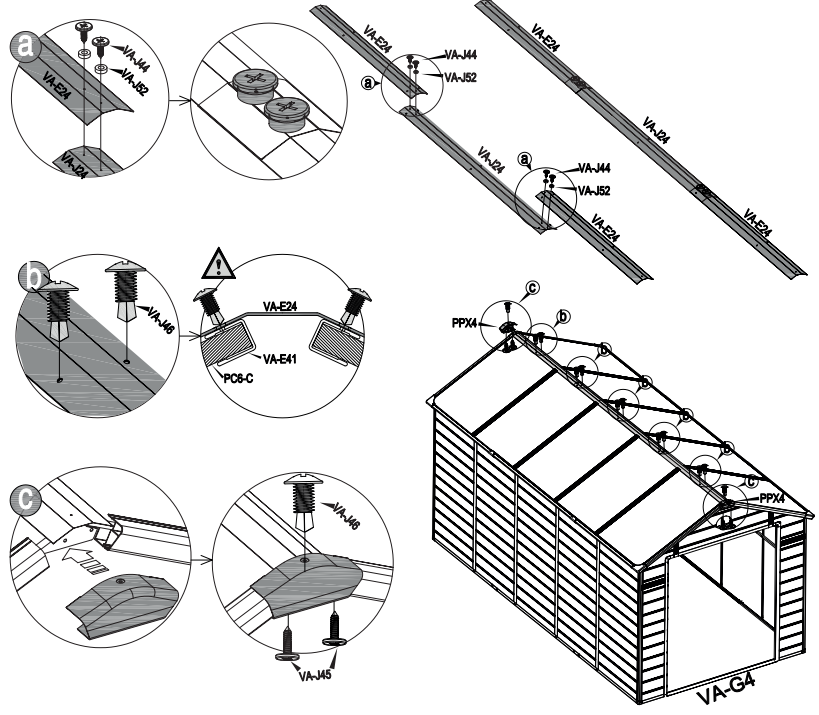

48	 VA-E24 [x2] 140mm	 VA-J24 [x1] 165mm	 PPX4 [x2]	 VA-J44 [x4] 19mm	 VA-J45 [x4] 19mm	 VA-J46 [x12] 19mm	 VA-J52 [x4]
-----------	--	--	---	---	---	--	---

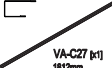

49	 PC75 [x1] 1810x74mm	 VA-C29 [x1] 1812mm	 VA-C27 [x1] 1812mm	 VA-C28 [x2] 892mm	 VA-J44 [x14] 13mm		
-----------	--	---	---	--	--	--	--

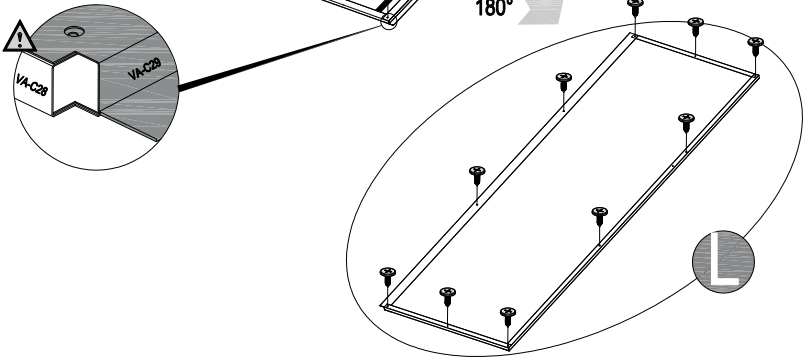
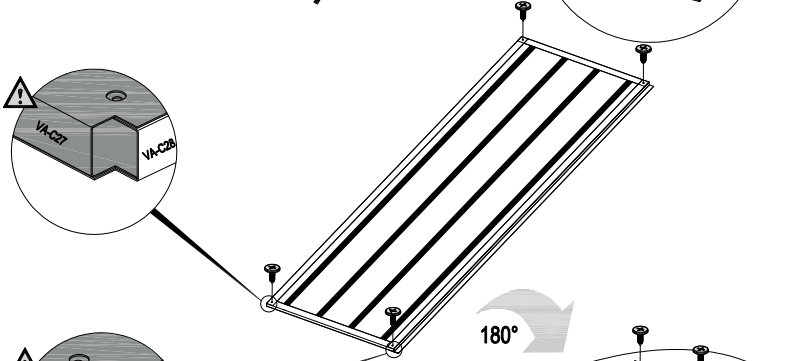
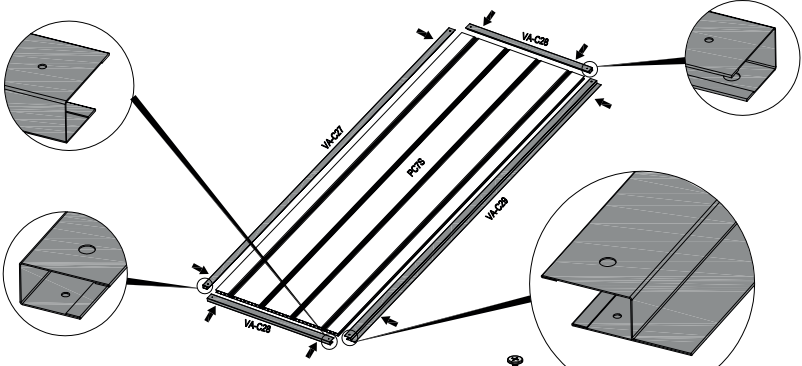

50	PC7S [x1] 1810x74mm		VA-C27 [x2] 1812mm	VA-C28 [x2] 952mm	VA-J44 [x1] 13mm			
-----------	------------------------	---	-----------------------	----------------------	---------------------	--	--	--

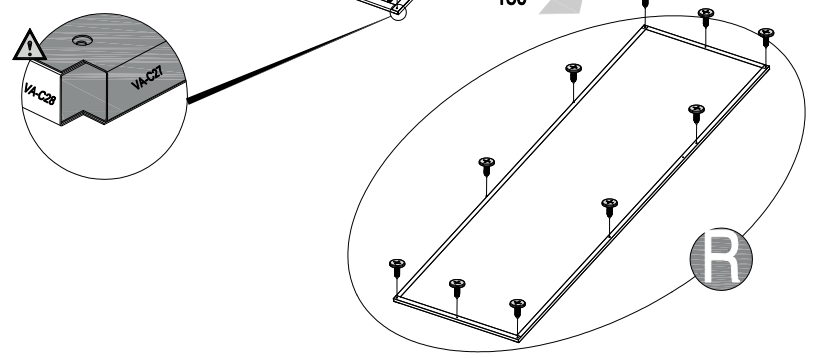
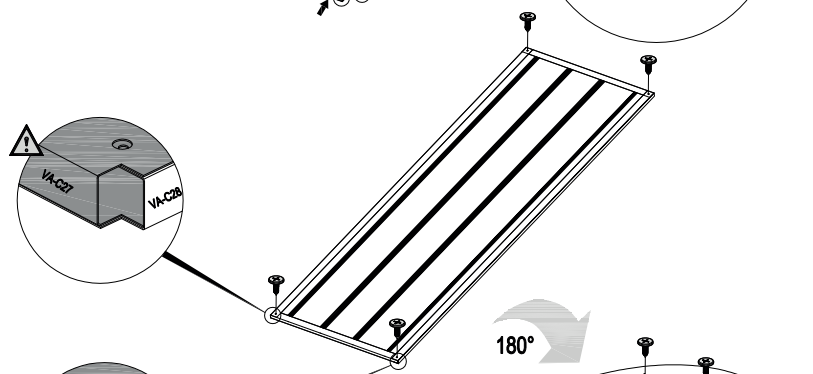
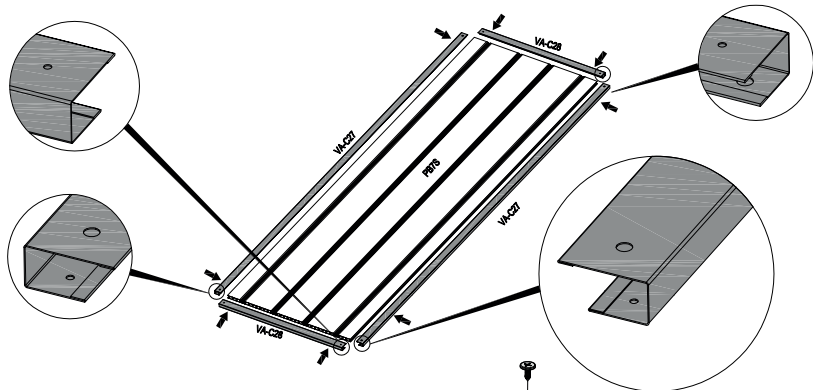

51	 VA-41 [p1]	 VA-40 [p1]	 PAD1 [p2]	 VA-J45 [p2] 16mm	 VA-J44 [p2] 13mm	 Ø2.5mm
----	---	---	--	--	--	---

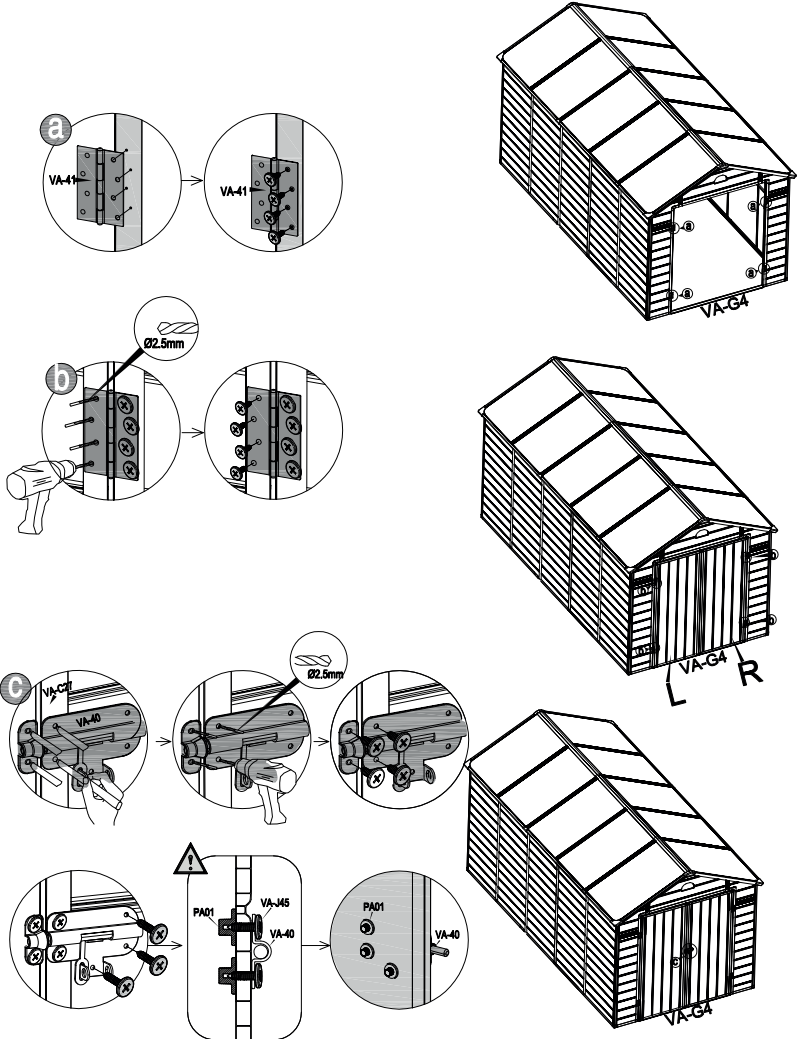

Window / Fenster / Okno / Okno / Ablak / Okno

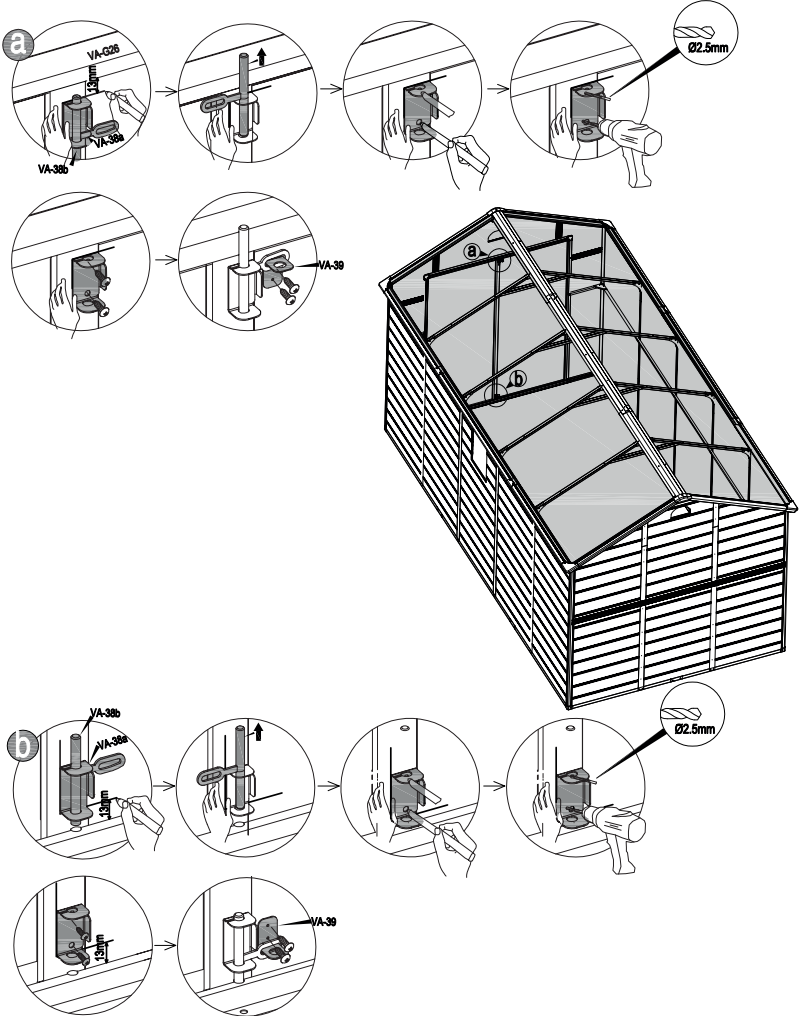
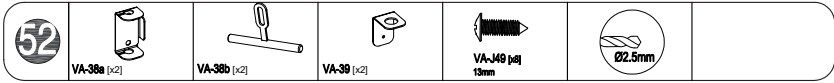

	<p>VA-36 [x2]</p>	<p>VA-32L [x2]</p>	<p>VA-32R [x2]</p>	<p>VA-37 [x10]</p>	<p>VA-J44 [x88] 12mm</p>	<p>VA-J48 [x10] 42mm</p>
--	-------------------	--------------------	--------------------	--------------------	------------------------------	------------------------------

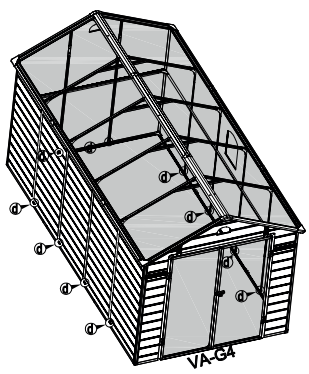
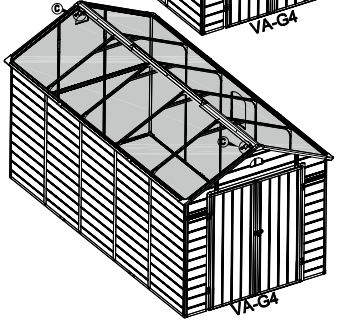
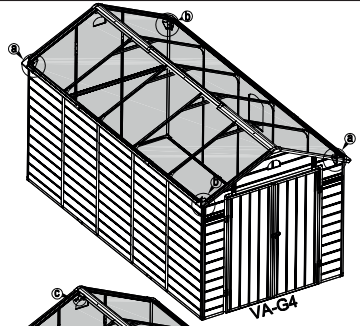
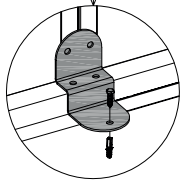
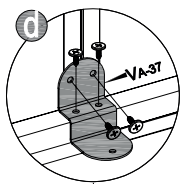
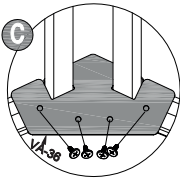
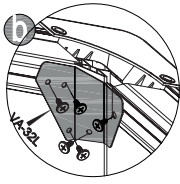
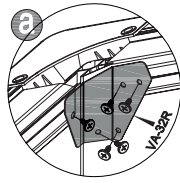

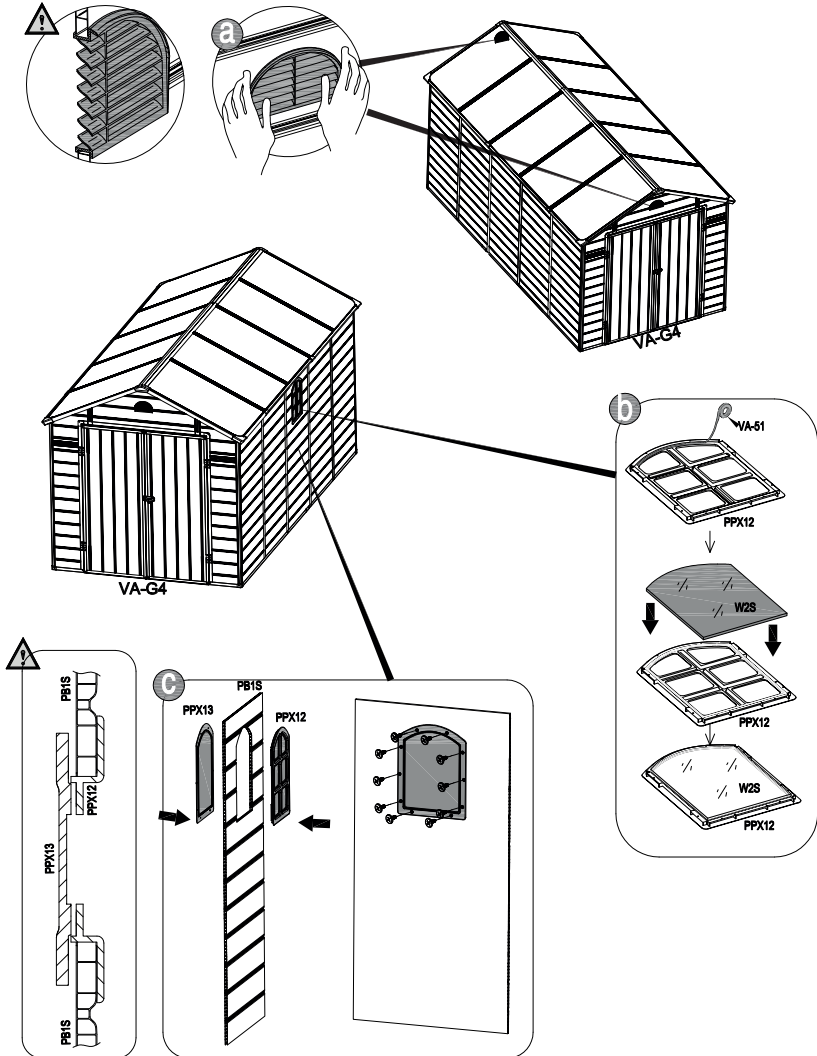
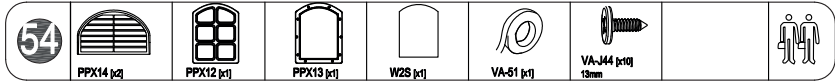



۲۷

